



Poltrona con struttura in massello di noce canaletta e rivestimento nei tessuti della collezione.

Easy chair with frame in solid canaletta walnut and cover in the fabrics of the collection.

Sessel mit Gestell aus massivem Nussbaum Canaletta und Bezug in den Stoffen der Kollektion.

Fauteuil avec structure en noyer massif et revêtement dans les tissus de la collection.

Butaca con estructura en nogal canaletta macizo y revestimiento en las telas de la colección.

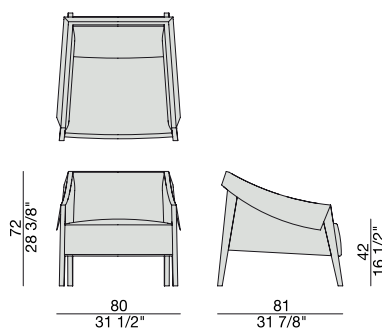

ESSENZE | *Essences*



Noce Canaletta
Canaletta Walnut

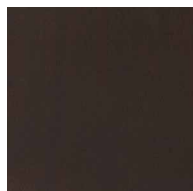

Noce Canaletta
Canaletta Walnut
tinto/stained moka

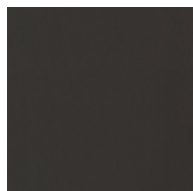

Noce Canaletta
Canaletta Walnut
tinto/stained wengé

LACCATO OPACO PORO CHIUSO | *Matt lacquered closed pore*

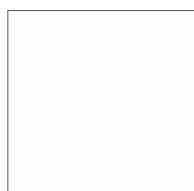

Bianco
White
(RAL 9016)

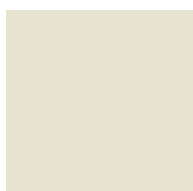

Avorio
Ivory
(RAL 1013)



Argilla
Mud
(RAL 7006)



Piombo
Lead
(NCS S5005G20Y)



Cioccolato
Chocolate
(RAL 8019)

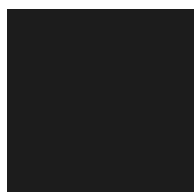

Nero
Black
(RAL 9005)



Granata
Garnet red
(NCS S4050Y90R)



Pistacchio
Pistachio green
(PANTONE 5825)



Avio
Aviation blue
(PANTONE 5415)

PELLE | *Leather*

Categoria LUX

Categoria PLUS

Categoria PELLE

Categoria EXTRA



Nabuk



Pelle PLUS



Pelle

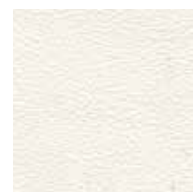

Pelle EXTRA

RIVESTIMENTO | Cover

Categoria A

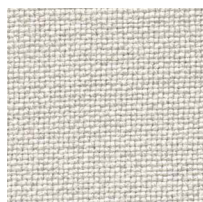

Hallingdal 65

Categoria B



Rabat

Categoria C



Fashion



Moran



Thalys



Velvet



Wool

Categoria D



Astra

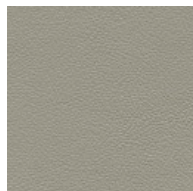

Ecopelle



Range



Tress

Categoria E

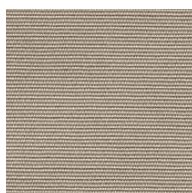

Cotone



Dorian



In Bianco/Calico

Categoria COM

Disponibile con tessuto fornito dal cliente. Tessuto richiesto cm. 400 x 140.

Available with fabric supplied by the customer. Fabric needed cm 400 x 140.

Verfügbar mit Kundenstoff cm. 400 x 140.

Disponibile avec tissu du client cm. 400 x 140.

Disponibile con tela suministrada por el cliente. Tela necesaria cm. 400 x 140.