

m o o o i<sup>®</sup>



## Zio Lounge Chair

---

by Marcel Wanders

Lean back, close your eyes, relax your arms on the smooth armrests and grant yourself the time to drift your imagination away, beyond your surroundings, into the street, beyond the starry night. Living your fantasies is easy while cosily sitting in the solid softness of Marcel Wanders' Zio lounge chair!

---

<b>Designer</b>	Marcel Wanders
<b>Year of design</b>	2013
<b>Material</b>	Solid oak frame

---

## Stain colours



White Wash



Wenge

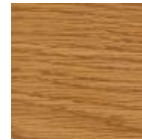

Natural Oil



Grey

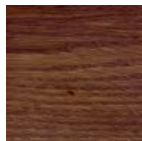

Cinnamon



Black Stained

Zio lounge chair, dining chair, dining table and coffee tables are also available in a composition of Cinnamon and White Washed stained oak.



Composition



Composition



Composition

## cleaning instructions

Moooi recommends using a good furniture polish and a soft cloth. Apply generously in layers to the surface and use the cloth to shine. Do not use abrasive fabrics, gently remove tough stains with warm water and a trusted multi-surface cleaner.

## packaging

### Zio Lounge Chair

H 86 cm | 33,9"

W 83 cm | 32,7"

D 83 cm | 32,7"

Colli 1/1

With packaging:

15 KG | 33,1 lb

### Zio Footstool

H 41 cm | 16,1"

W 59 cm | 23,2"

D 59 cm | 23,2"

Colli 1/1

With packaging:

10 KG | 22 lb

## dimensions

# m o o o i<sup>®</sup>

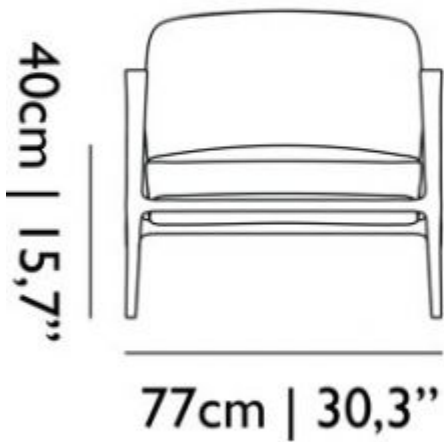
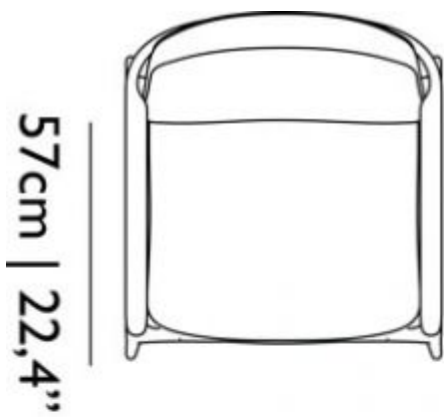

77cm | 30,3"



85cm | 33,5"

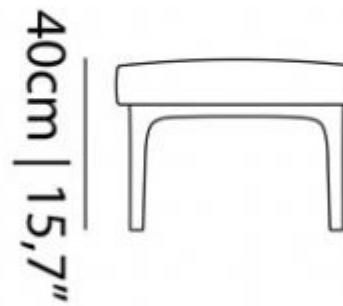
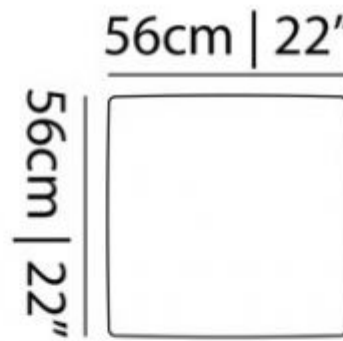

---

## Macchedil, Grezzo

### composition

47% co, 20% vi, 18% pi, 8% li, 5% pc, 2% af

### abrasion

18.000 martindale

### lightfastness 4

### firetest

EN1021 I&2



## Macchedil, Sottile

### composition

49% vi, 24% pl, 21% li, 6% co

### abrasion

30.000 martindale

### lightfastness 4

### firetest

EN1021 I&2



## Abbracci

# m o o o i<sup>®</sup>

## composition

100% pl

## abrasion

50.000 martindale

## lightfastness 4

## firetest

FR BS5852 0/1

EN1021 I&2

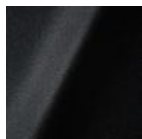

Abbracci  
**Black**

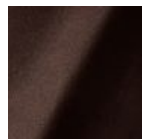

Abbracci  
**Brown**

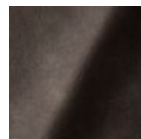

Abbracci  
**Grey**



Abbracci  
**Oyster**

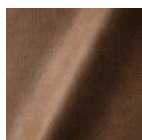

Abbracci  
**Taupe**

---

## Manga

## composition

29% pl, 71% co

## abrasion

40.000 martindale

## lightfastness 5

## firetest

FR BS5852 0/1

EN1021 I&2

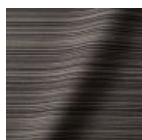

Manga  
**Grey**



Manga  
**Blue**



Manga  
**Green**

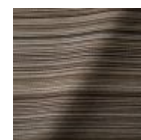

Manga  
**Brown**

---

## Oray

# m o o o i<sup>®</sup>

## composition

8% co, 38% vi, 15% pl, 39% li

## abrasion

30.000 martindale

## lightfastness 4

## firetest

FR BS5852 0/1

EN 1021 1&2



Oray  
**Cream**



Oray  
**Sand**

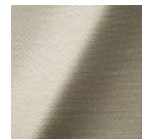

Oray  
**Rock**



Oray  
**Mineral**

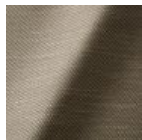

Oray  
**Gravel**

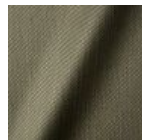

Oray  
**Dark Gull**

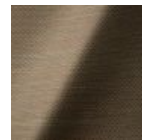

Oray  
**Copper**



Oray  
**Rust**

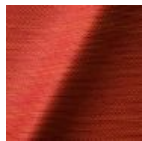

Oray  
**Flamboyant**

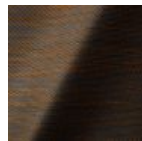

Oray  
**Oil**

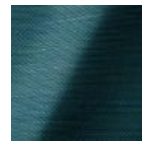

Oray  
**Aqua**

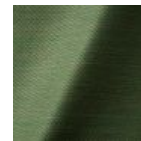

Oray  
**Peyote**



Oray  
**Ocean**

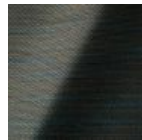

Oray  
**Metal**



Oray  
**Griffin**



Oray  
**Dusk**



Oray  
**Chestnut**



Oray  
**Dark**

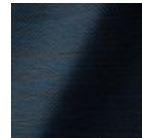

Oray  
**Indigo**



Oray  
**Ochre**

---

## Solis

# m o o o i<sup>®</sup>

## composition

2% PA 3% PC 30% PL 65% WO

## abrasion

40.000 Martindale rubs, EN ISO 12947

## lightfastness

Note 5, EN ISO 105-B02

## firetest

EN 1021-1/2

US. Cal. Bull. 117-2013

Upon request, with treatment:

BS5852 part 1

BS5852 crib 5



Solis  
Crust



Solis  
**Dawn**



Solis  
**Fog**



Solis  
**Gray**



Solis  
**Paper**



Solis  
**Rain**



Solis  
**Spencer**

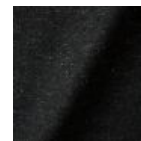

Solis  
**Suit**

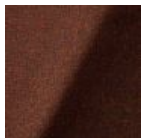

Solis  
**Sunset**

---

## Jacquard andaz

### composition:

34% cotton - 30% viscose - 24% linen - 12% polyamide

### abrasion:

25000 martindale

### lightfastness 4-5

### firetest:

BS EN 1021 1&2

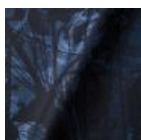

Jacquard  
**Andaz**

## Jaquard Fresco

**composition**

40% vi ,36% co,14% pl, 10% li

**abrasion**

20.000> martindale

**lightfastness** 4-5

**firetest**

EN1021 I&2



Jaquard  
**Fresco**

---

## Jacquard Old Black & Blue

**composition**

52% vi, 38% co, 10% li

**abrasion**

20.000> martindale

**lightfastness** 4-5

**firetest**

EN1021 I&2



Jaquard  
**Old Blue**



Jaquard  
**Old Black**

---

## Justo



# m o o o i<sup>®</sup>

## composition

15% CO, 35% PC, 10% PL, 40% VI

## abrasion

50.000 Martindale rubs, EN ISO 12947

## lightfastness

Note 5, EN ISO 105-B02

## fire test

EN 1021-1/2

US. Cal. Bull. 117-2013

NFPA 260

Upon request, with treatment:

BS5852 part1

BS5852 crib5



Justo  
**Alge**

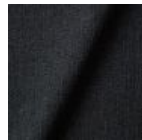

Justo  
**Bazalt**

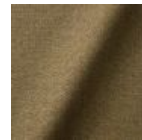

Justo  
**Bred**

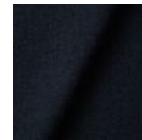

Justo  
**Flod**

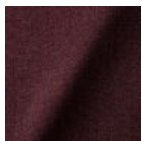

Justo  
**Hinde**

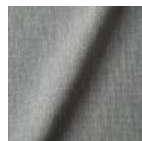

Justo  
**Lyse**



Justo  
**Muse**

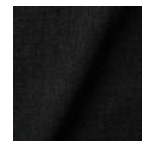

Justo  
**Nat**

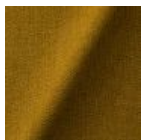

Justo  
**Sennep**

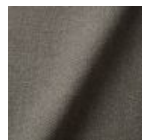

Justo  
**Sten**

---

## Liscio

## composition

35% WO / 35% CV / 21% CO / 9% PA

## abrasion

30.000 Martindale

## lightfastness

4-6

## firetest

US. Cal. Bull. 117-2013

Upon request, with treatment:

BS5852 part1



Liscio  
**Grigio Blu  
Scuro**



Liscio  
**Grigio Blu**



Liscio  
**Grigio Scuro**



Liscio  
**Muscio Scuro**



Liscio  
**Muscio**



Liscio  
**Argento**



**Liscio**  
Nebbia

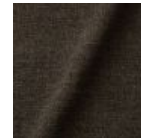

Liscio  
**Pietra**



Liscio  
**Perla**



Liscio  
**Latte Scuro**



Liscio  
**Latte**

## Trickle

### composition

60% WO / 20% PES / 20% PA

### abrasion

80.000 martindale

### lightfastness 6

### firetest

EN1021-1/2

US. Cal. Bull. 117-2013

BS5852 part I

DIN 4102-B2



Trickle  
**Flour**

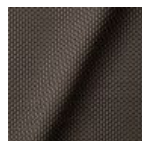

Trickle  
**Twig**

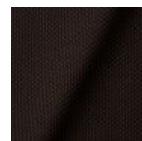

Trickle  
**Peat**



Trickle  
**Dust**

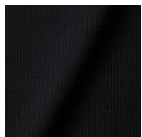

**Trickle**  
Slate

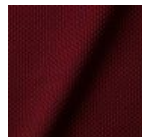

Trickle  
**Chili**



Trickle  
**Lavender**



Trickle  
**Lagoon**

## Twill

# m o o o i<sup>®</sup>

## composition

72% wo, 8% pa, 20% pl

## abrasion

75.000 martindale

## lightfastness 5

## firetest

EN1021 I&2



Twill  
**Caviar**

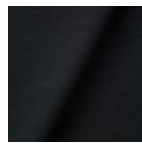

Twill  
**Graphite**

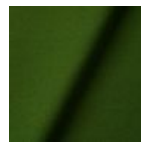

Twill  
**Grass**



Twill  
**Grey**



Twill  
**Linen**

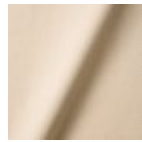

Twill  
**Natural**



Twill  
**Passion**

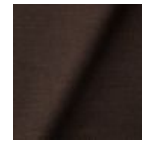

Twill  
**Walnut**

---

## Twill Melange

### composition

60% WO / 20% PES / 20% PA

### abrasion

80.000 martindale

### lightfastness 6-7

### firetest

EN1021-I/2

US. Cal. Bull. 117-2013

BS5852 part I

DIN 4102-B2

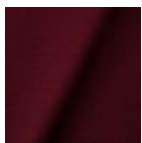

Twill Melange  
**Chili**



Twill Melange  
**Dust**

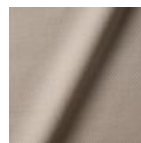

Twill Melange  
**Flour**

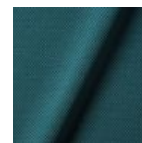

Twill Melange  
**Lagoon**



Twill Melange  
**Lavender**

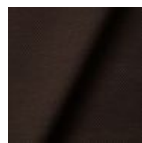

Twill Melange  
**Peat**

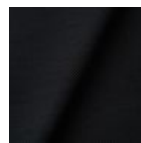

Twill Melange  
**Slate**



Twill Melange  
**Twig**

---

## Velour

# m o o o i<sup>®</sup>

## composition

77% wo, 8% pa, 15% pl

## abrasion

100.000 martindale

## lightfastness 7

## firetest

FR BS5852 0/1

EN1021 I&2



Velour  
**Coral**



Velour  
**Stone**



Velour  
**Moss**

---

## Vesper

## composition

10% CO, 40% L, 10% PA, 10% PL, 30% VI

## abrasion

40.000 Martindale rubs, EN ISO 12947

## lightfastness

Note 5, EN ISO 105-B02

## firetest

EN 1021-1/2

US. Cal. Bull. 117-2013

Upon request, with treatment:

BS5852 part I

BS5852 crib5



Vesper  
**Aluminium**

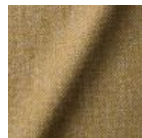

Vesper  
**Brass**

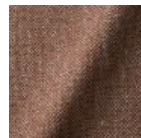

Vesper  
**Bronze**



Vesper  
**Carbon**



Vesper  
**Nickel**



Vesper  
**Silver**

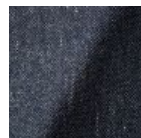

Vesper  
**Steel**



Vesper  
**Titan**

---

## Tartanic

**composition**

64% VI / 27% CO / 9% PA



---

## Extinct Animal Collection - Dodo Pavone

**composition**

12% CO 88% PL

**abrasion**

40.000 Martindale rubs, EN ISO 12947

**lightfastness**

Note 5, EN ISO 105-B02

**firetest**

US. Cal. Bull. 117-2013

Upon request, with treatment:

BS5852 part I

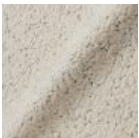

---

## Arredo Leather

**composition**

100% semi aniline leather

Leather is a natural product, colours may vary from hide to hide.

**firetest**

EN1021 I&2

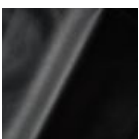

Arredo Leather  
**Black**

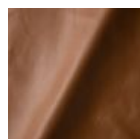

Arredo Leather  
**Brown**

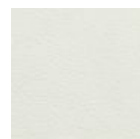

Arredo Leather  
**White**

---

## Cervino Leather



#### **composition**

100% aniline leather

Leather is a natural product, colours may vary from hide to hide.

#### **firetest**

EN1021 I&2



Cervino Leather  
**Anthracite**

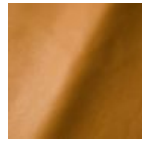

Cervino Leather  
**Cognac**



Cervino Leather  
**Mud**

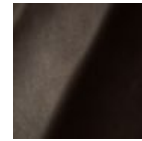

Cervino Leather  
**Pure**

---

## **Kvadrat Fabrics**

### **Kvadrat Fabrics**

Selected Moooi products can be upholstered with a collection of Kvadrat fabrics. Kvadrat designs high-quality upholstery, in an extensive range of colours and textures.

Go to our [Kvadrat fabrics page](#) for a full overview of all fabric families you can choose from.

