

UBIQUA S

T. Colzani

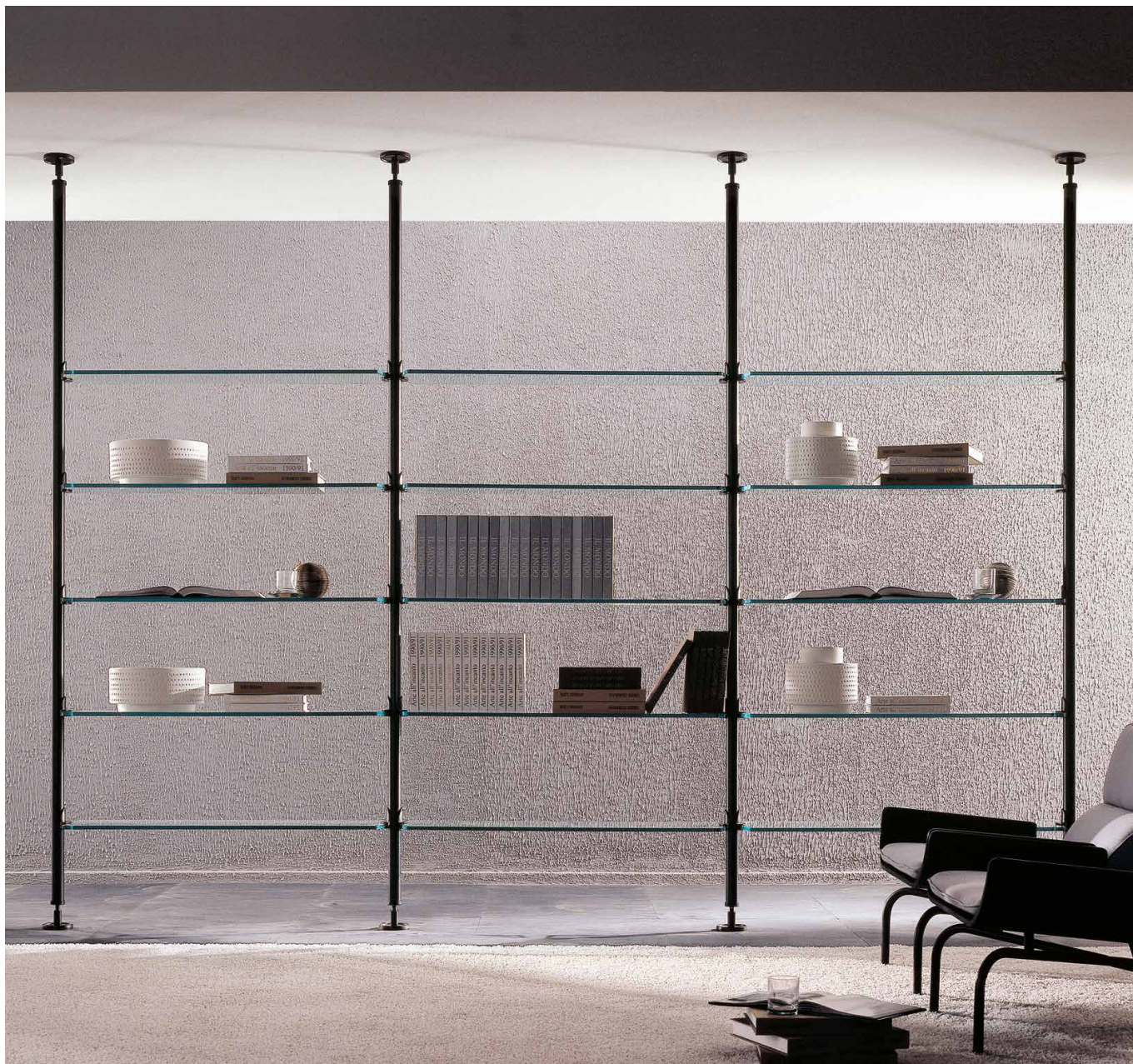

Colonna forzata tra pavimento e soffitto in metallo. Le colonne possono essere centrali oppure laterali.

Column in metal forced between floor and ceiling. The columns can be lateral (holes along one row) or central (holes along two rows).

Die Säule Boden/Decke ist verfügbar aus Metal.

La colonne sol/plafond est en métal.

Columna fijada entre el suelo y el techo en metal. Las columnas pueden ser laterales (agujeros por un solo lado) o centrales (agujeros por los dos lados).

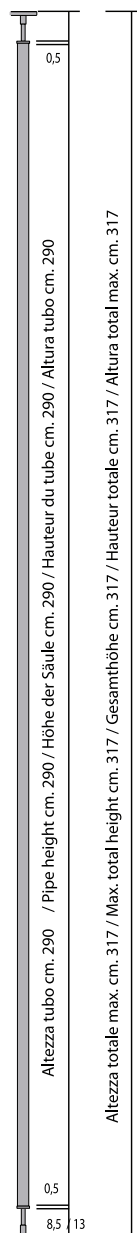

COMPOSIZIONI | Compositions

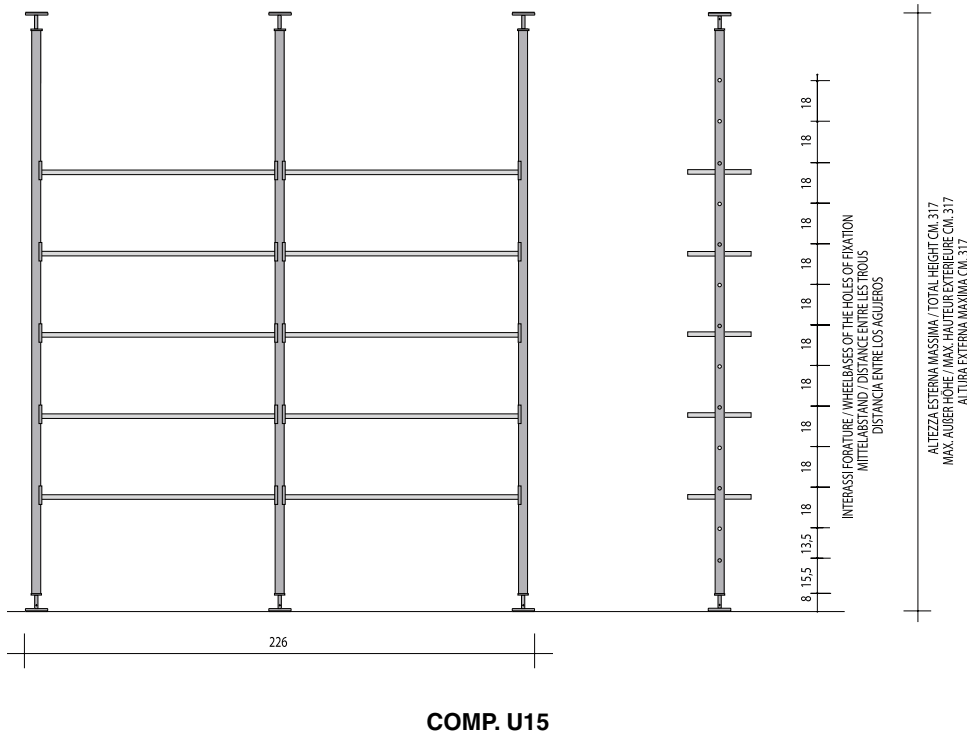
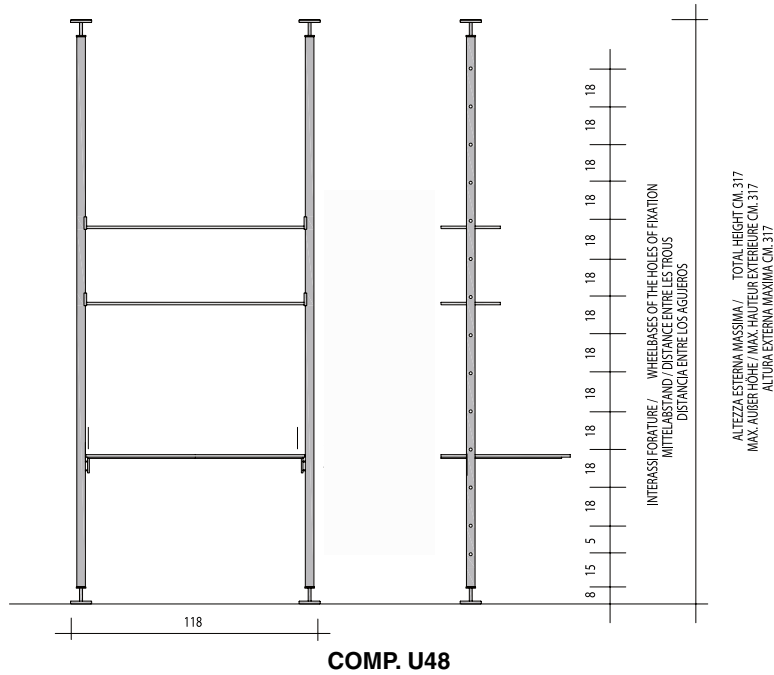

COMPOSIZIONI | *Compositions*

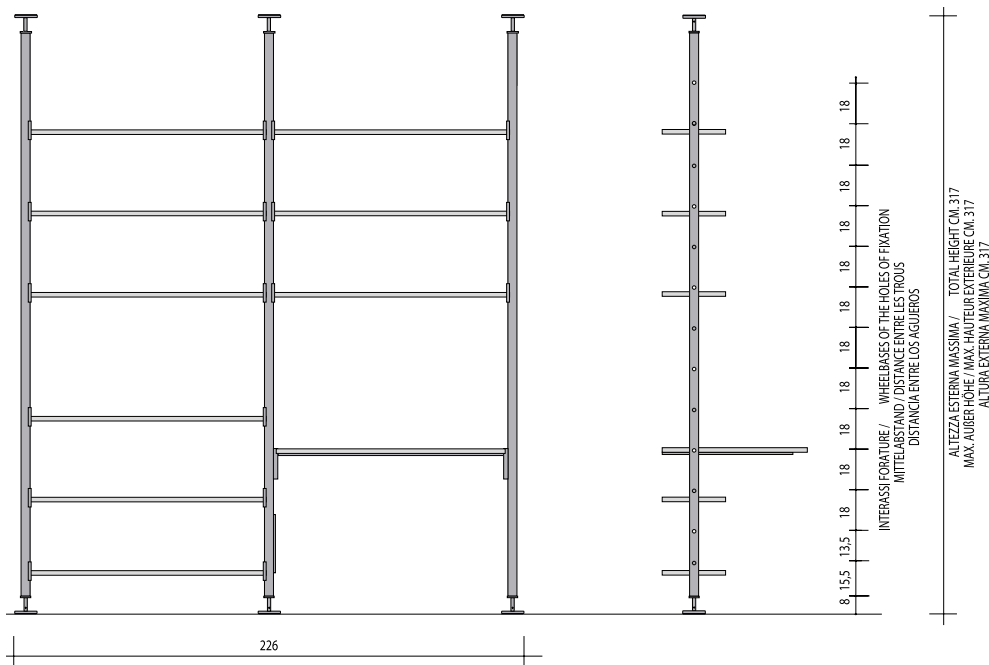

COMP. U33

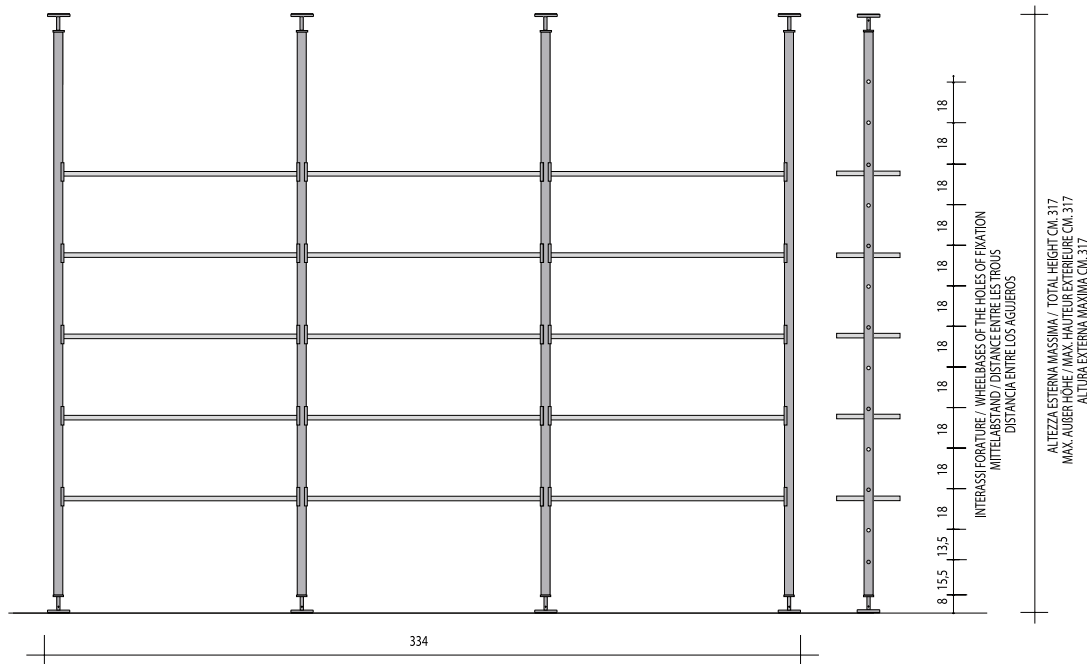

COMP. U46

COMPOSIZIONI | *Compositions*

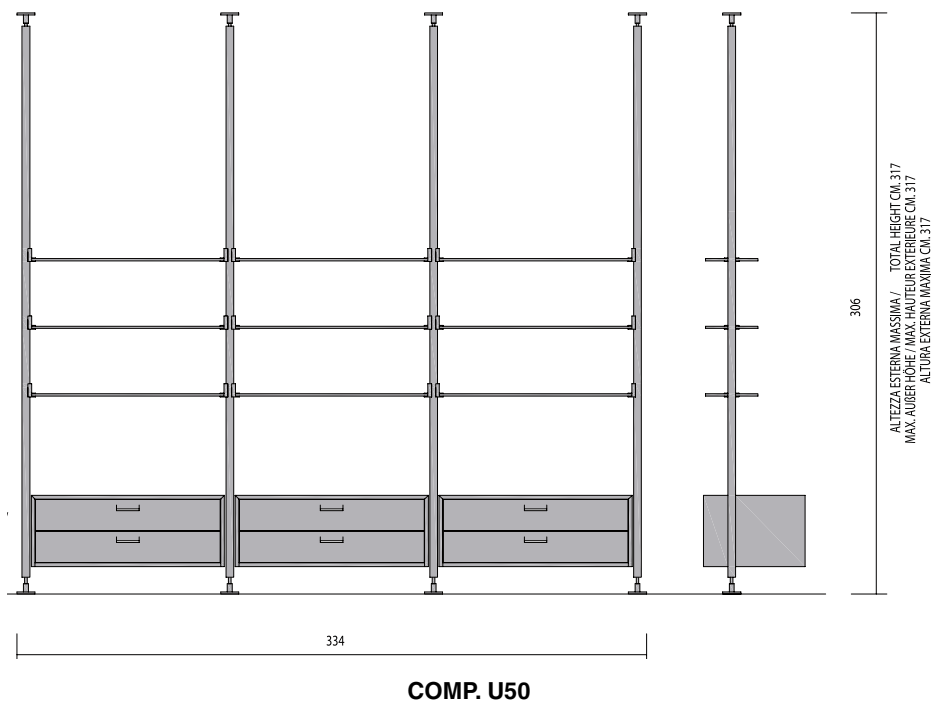

UBIQUA S GIREVOLE

T. Colzani

La colonna girevole può essere fissata tra pavimento e soffitto oppure alla parete mediante un apposito elemento di fissaggio. Internamente la colonna prevede dei fori per il fissaggio degli accessori.

The swivelling column can be fixed to the ceiling or to the wall thanks to its proper element of fixation. Along the column we have foreseen holes for the fixation of the accessories.

Die drehbare Säule wird zwischen der Decke und dem Boden oder an der Wand befestigt. An jeder Seite sind Gewindenvorrichtungen für diese Befestigung vorgesehen.

La colonne pivotante peut être fixée entre sol et plafond ou fixée au mur par une fixation murale. Sur le cadre on a prévu des trous sur chaque côté dans lesquelles fixer les accessoires.

La columna giratoria puede ser fijada entre suelo y techo a pared gracias a su elemento de fijación. Por toda la columna hay agujeros para la fijación de los accesorios.

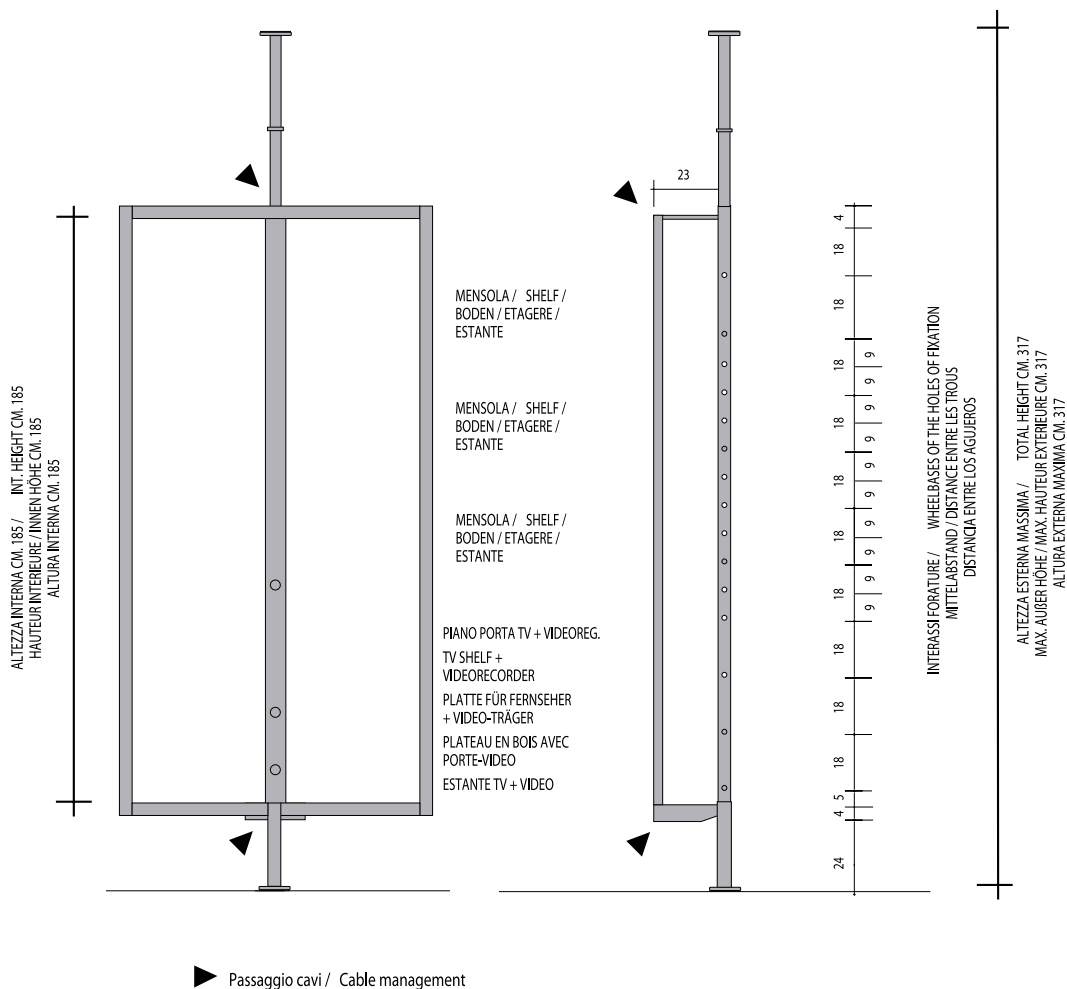

UBIQUA S GIREVOLE

T. Colzani

COMPOSIZIONI | *Compositions*

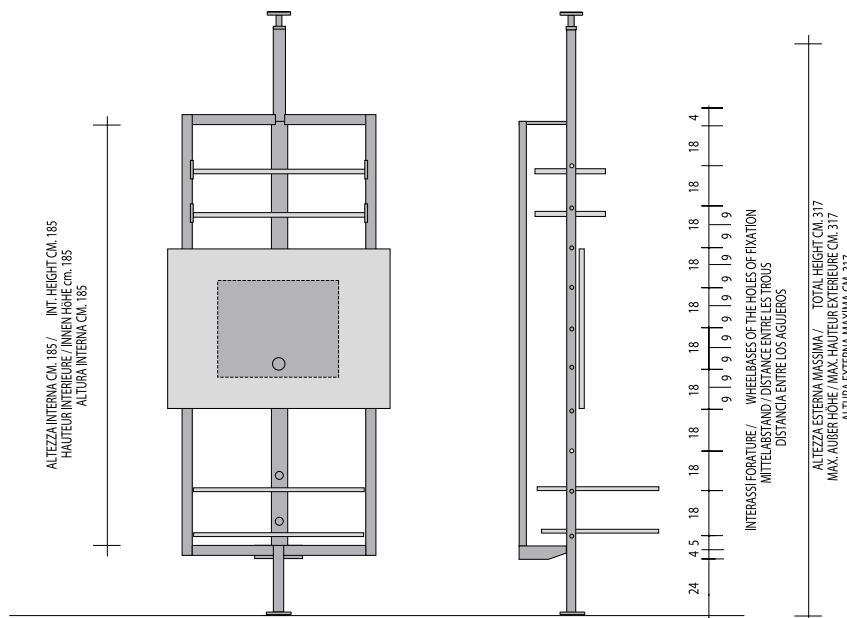

COMP. U43

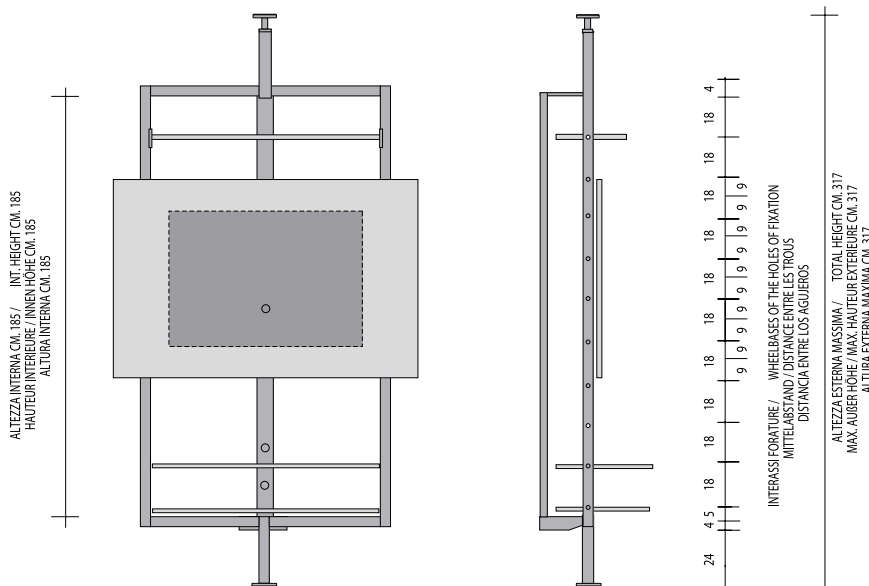

COMP. U36

UBIQUA P

T. Colzani



UBIQUA P

T. Colzani

Colonna in metallo fissata tra pavimento e parete mediante apposito attacco. Le colonne possono essere centrali oppure laterali.

Column in metal fixed to the wall. The columns can be lateral (holes along one row) or central (holes along two rows).

Die Wandsäule ist verfügbar aus Metal.

La colonne sol/mur est en métal.

Column fijada a pared en metal. Las columnas pueden ser laterales (agujeros por un solo lado) o centrales (agujeros por los dos lados).

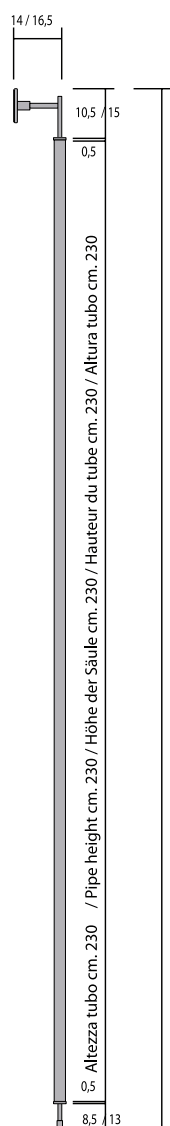

Altezza totale regolabile da cm. 248 (min.) a cm. 259 (max)
Total height adjustable between cm. 248 (min.) and cm. 259 (max)
Gesamthöhe cm. min. 248 - max. 259 / Hauteur totale min. 248 - max. 259
Altezza totale regolabile entre cm. 248 y cm. 259

COMPOSIZIONI | *Compositions*

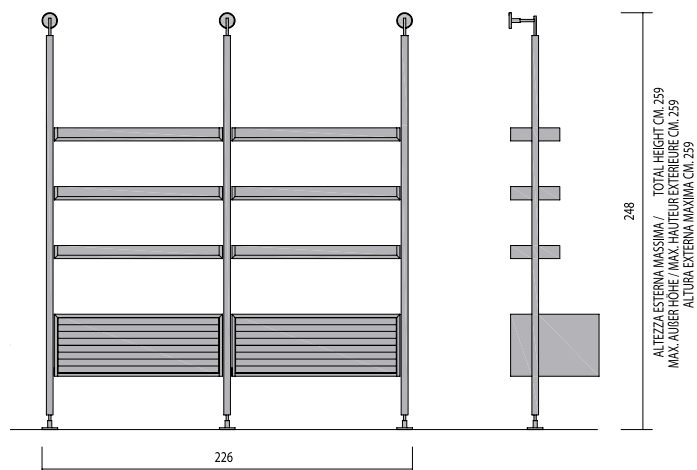

COMP. U52

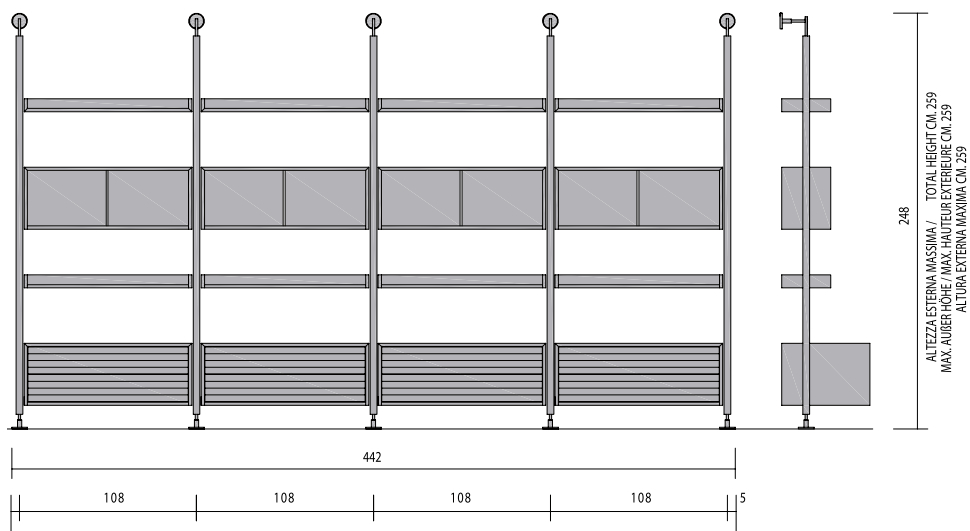

COMP. U51

UBIQUA P GIREVOLE

T. Colzani

La colonna girevole può essere fissata tra pavimento e soffitto oppure alla parete mediante un apposito elemento di fissaggio. Internamente la colonna prevede dei fori per il fissaggio degli accessori.

The swivelling column can be fixed to the ceiling or to the wall thanks to its proper element of fixation. Along the column we have foreseen holes for the fixation of the accessories.

Die drehbare Säule wird zwischen der Decke und dem Boden oder an der Wand befestigt. An jeder Seite sind Gewindenvorrichtungen für diese Befestigung vorgesehen.

La colonne pivotante peut être fixée entre sol et plafond ou fixée au mur par une fixation murale. Sur le cadre on a prévu des trous sur chaque côté dans lesquelles fixer les accessoires.

La columna giratoria puede ser fijada entre suelo y techo a pared gracias a su elemento de fijación. Por toda la columna hay agujeros para la fijación de los accesorios.

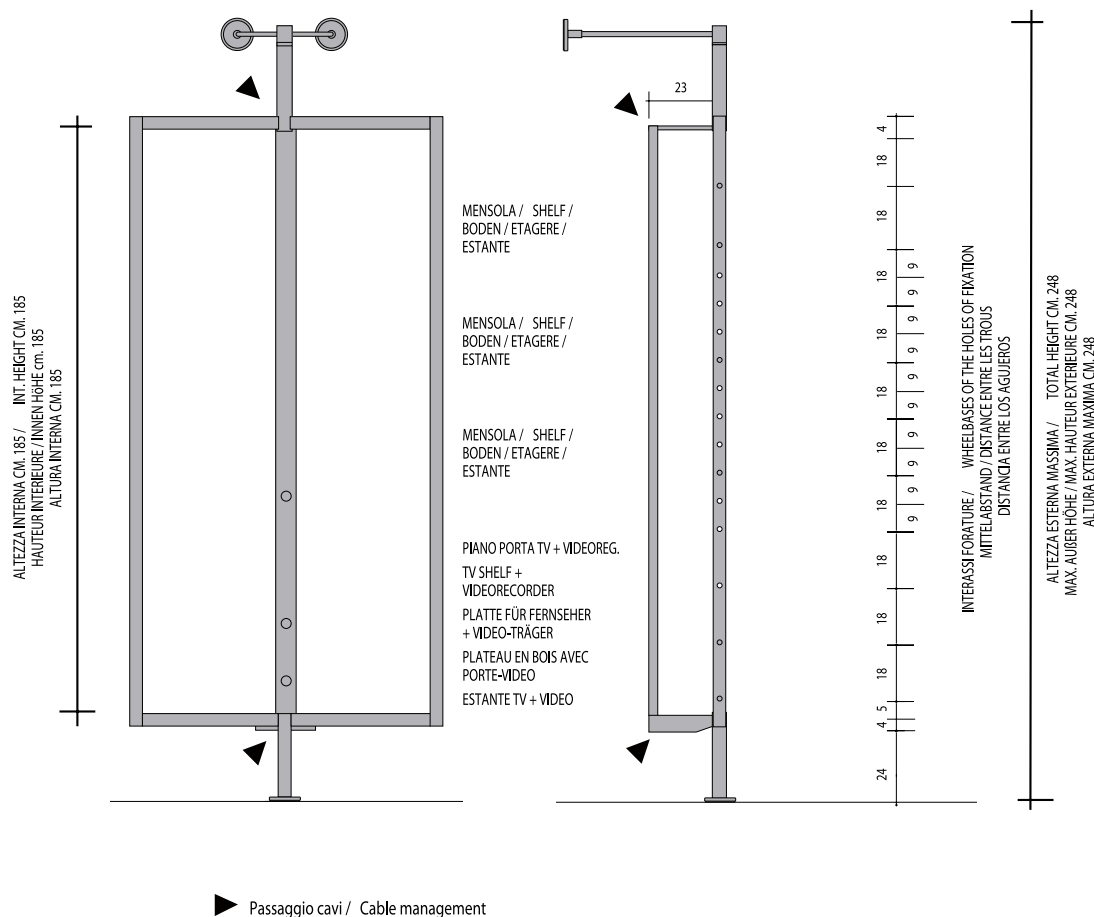

UBIQUA P GIREVOLE

T. Colzani

COMPOSIZIONI | *Compositions*

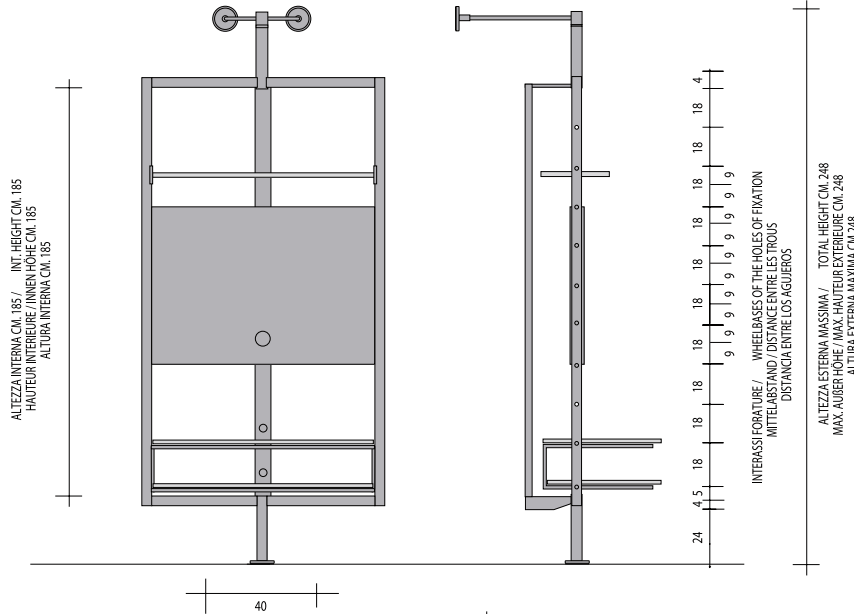

COMP. U28

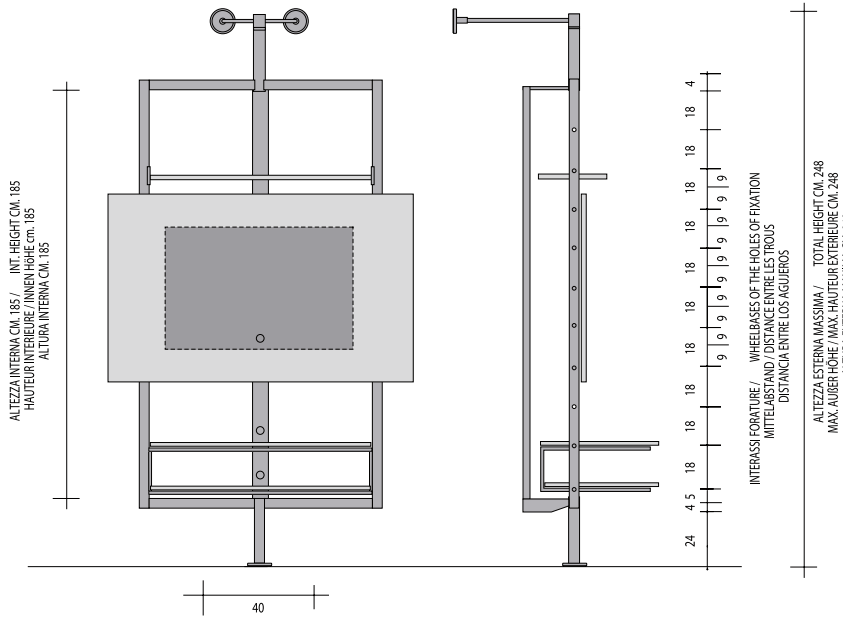

COMP. U29

UBIQUA A

T. Colzani



UBIQUA A

T. Colzani

Colonna a telaio autoportante orientabile in metallo.

Freestanding swivelling column in metal.

Freistehende verstellbare Säule aus Metal.

Colonne pivotante autoportante en métal.

Columna giratoria autoportante orientable en metal.

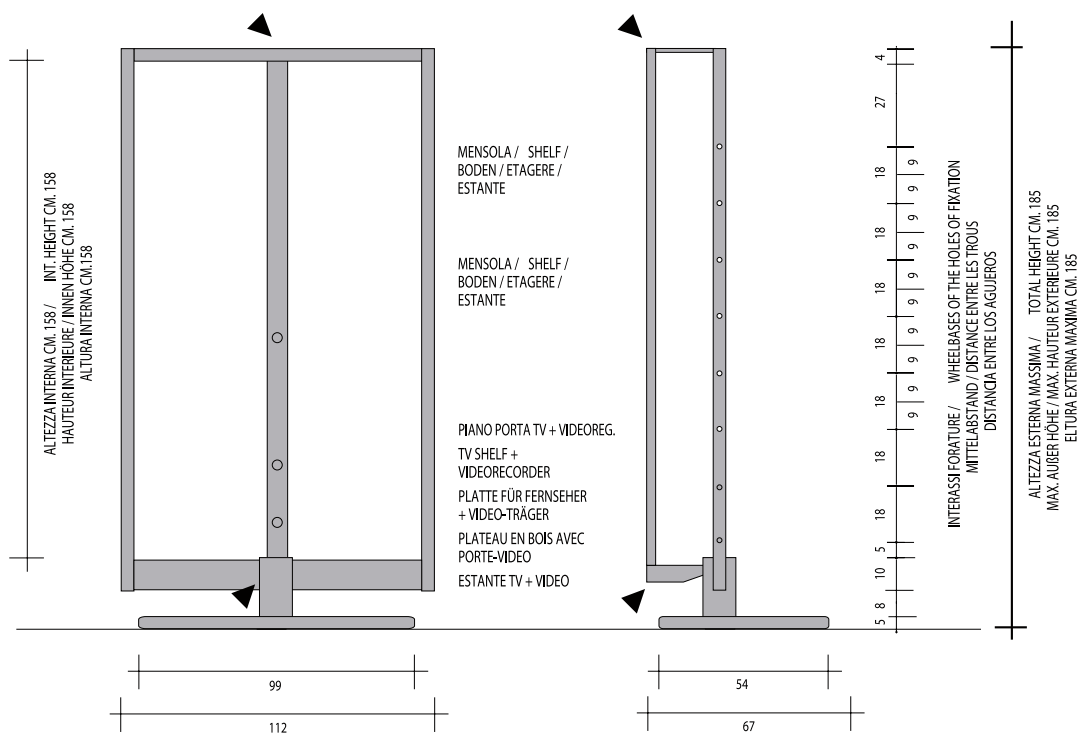

► Passaggio cavi / Cable management

COMPOSIZIONI | *Compositions*

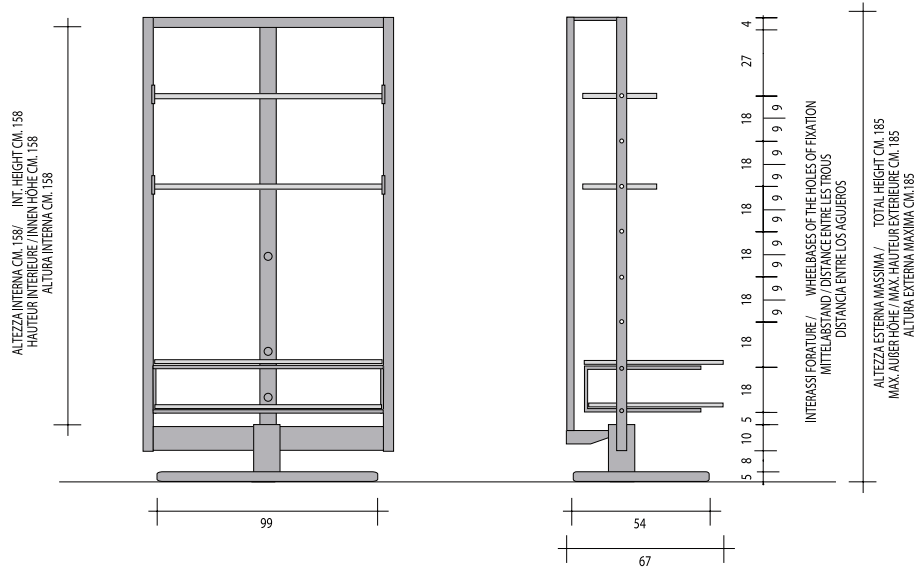

COMP. U27

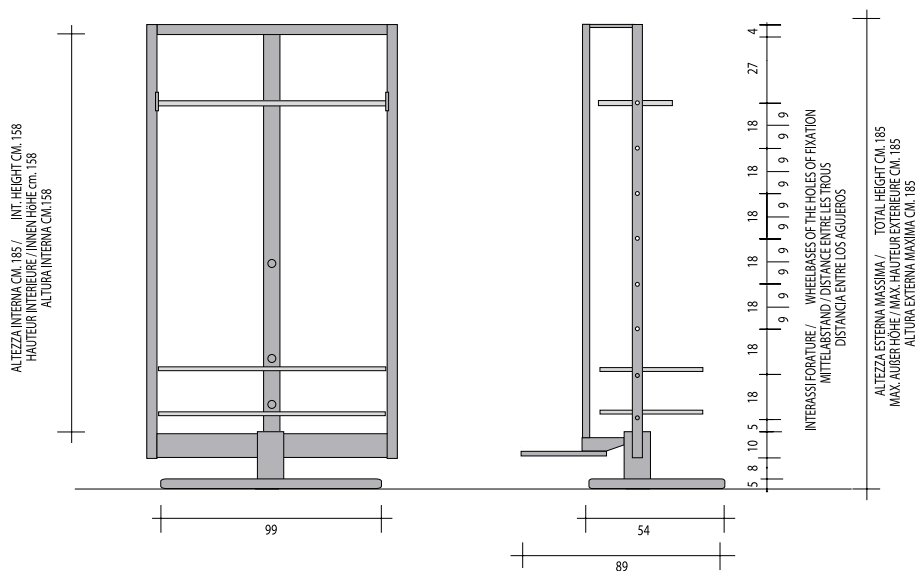

COMP. U42

COMPOSIZIONI | Compositions

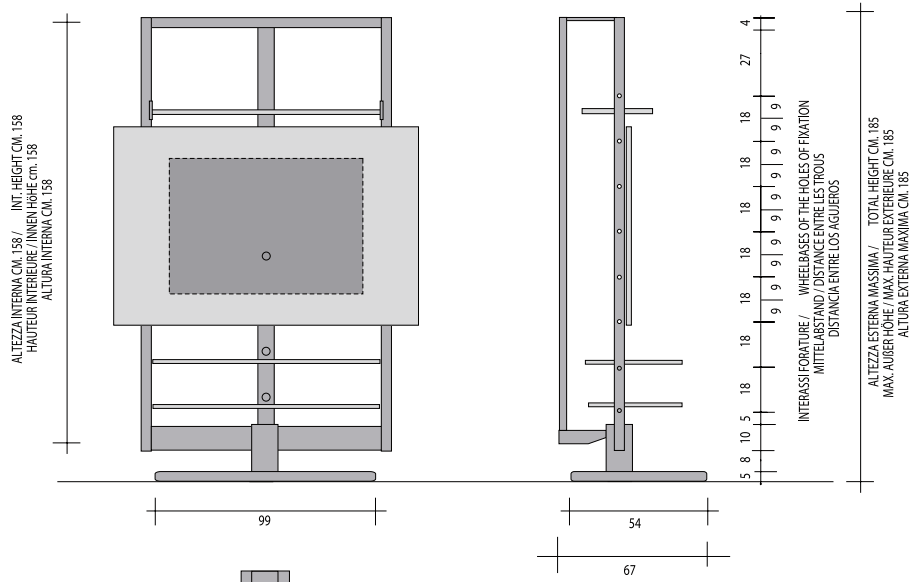

COMP. U41

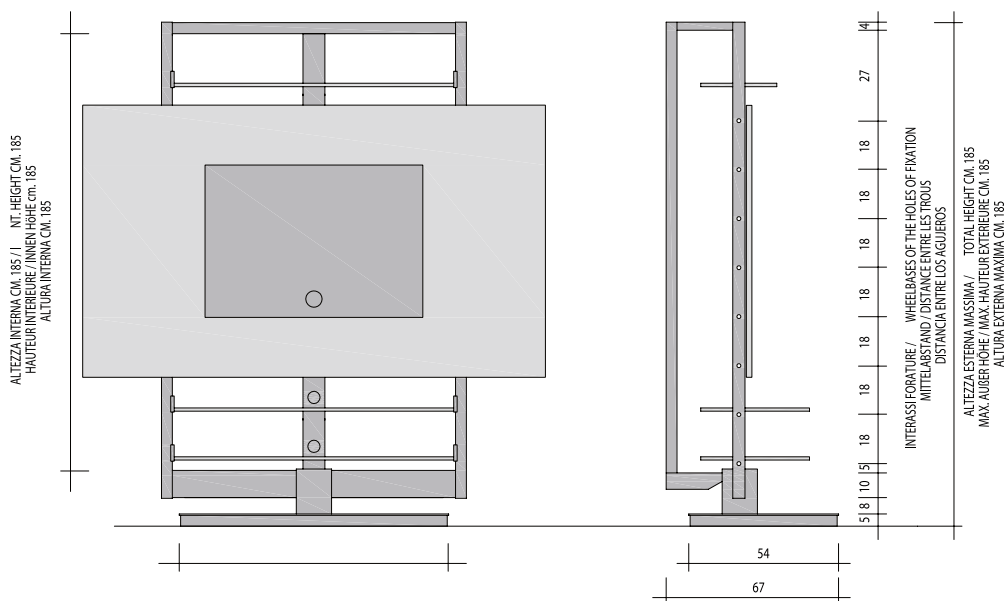

COMP. U47

ACCESSORI | *Accessories*

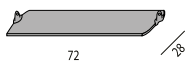

MENSOLA IN CRISTALLO
Glass Shelf
cm. 72x28

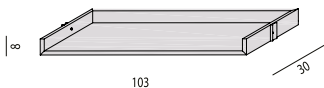

MENSOLA IN LEGNO
Wooden Shelf
cm. 103x30

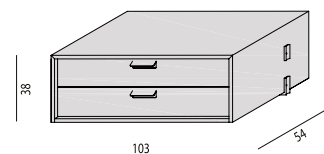

CASSETTIERA IN CUOIO
Leather Chest of Drawers
cm. 103x54

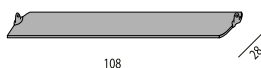

MENSOLA IN CRISTALLO
Glass Shelf
cm. 108x28

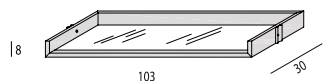

MENSOLA IN CRISTALLO
Glass Shelf
cm. 103x30

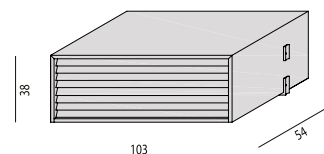

CASSETTIERA IN LEGNO
Wooden Chest of Drawers
cm. 103x54

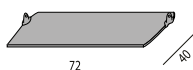

MENSOLA IN CRISTALLO
Glass Shelf
cm. 72x40

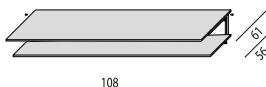

PIANO TV IN CRISTALLO
Glass TV-Shelf
cm. 108x61

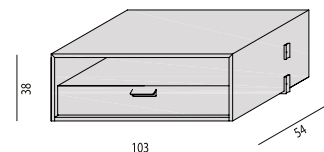

MOBILE A GIORNO IN CUOIO
Leather container with open compartment
cm. 103x54

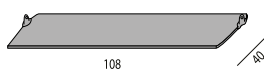

MENSOLA IN CRISTALLO
Glass Shelf
cm. 108x40

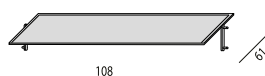

PIANO SCRITTOIO IN CRISTALLO
Glass Writing Desk
cm. 108x61

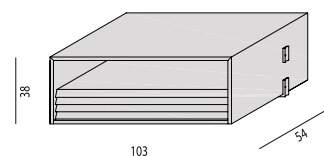

MOBILE A GIORNO IN LEGNO
Wooden container with open compartment
cm. 103x54

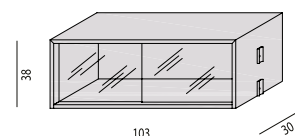

VETRINA
Cabinet
cm. 103x30

ACCESSORI | Accessories

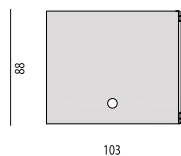

PANNELLO PORTA TV IN LEGNO
Wooden board for flat TV
cm. 103

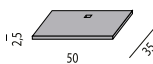

PORTA SUB-WOOFER
Sub-woofer Holder

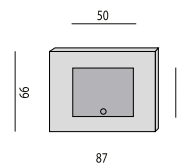

PANNELLO PORTA TV IN CRISTALLO
Glass board for flat TV
cm. 72

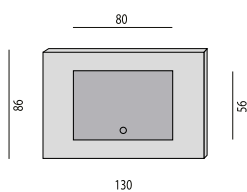

PANNELLO PORTA TV IN CRISTALLO
Glass board for flat TV
cm. 130

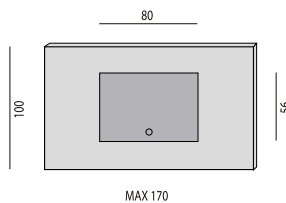

PANNELLO PORTA TV IN CRISTALLO
Glass board for flat TV
cm. 170

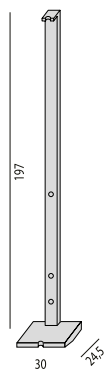

PORTA CAVI
Channel for cables

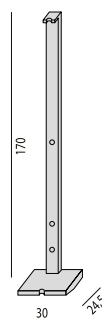

PORTA CAVIPER AUTOPORTANTE
Channel for cables for freestanding column

In eliminazione. Richiedere disponibilità.

Discontinued item. Please check availability.

Der Artikel ist aus der Produktion, bitte die Verfügbarkeit anfragen.

Article pas plus en collection. Disponibilité en stock à vérifier.

En eliminación. Consultar disponibilidad.

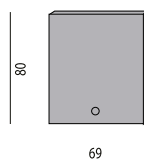

PANNELLO PORTA TV IN LEGNO CM. 72
Wooden board for flat TV cm. 72

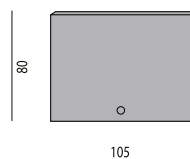

PANNELLO PORTA TV IN LEGNO CM. 108
Wooden board for flat TV cm. 108

ESSENZE | *Essences*



Noce Canaletta
Canaletta Walnut



Noce Canaletta
Canaletta Walnut
tinto/stained wengé

LACCATO OPACO PORO CHIUSO | *Matt lacquered closed pore*

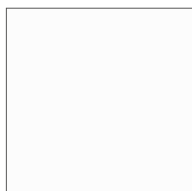

Bianco
White
(RAL 9016)

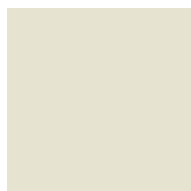

Avorio
Ivory
(RAL 1013)



Argilla
Mud
(RAL 7006)



Piombo
Lead
(NCS S5005G20Y)



Cioccolato
Chocolate
(RAL 8019)

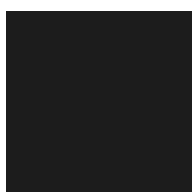

Nero
Black
(RAL 9005)



Granata
Garnet red
(NCS S4050Y90R)



Pistacchio
Pistachio green
(PANTONE 5825)



Avio
Aviation blue
(PANTONE 5415)

CRISTALLO | *Glass*



Trasparente
Transparent



Fumé
Smoked

RIVESTIMENTO | *Cover*

Cuoietto

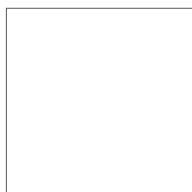

Bianco
White

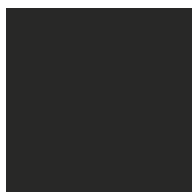

Nero
Black

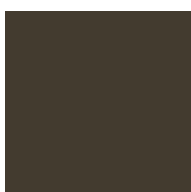

Testa di moro
Dark Brown



Bulgaro
Bulgaro Red



Naturale
Natural

METALLO | *Metal*



Bronzoro

In eliminazione. Richiedere disponibilità.

Discontinued item. Please check availability.

Der Artikel ist aus der Produktion, bitte die Verfügbarkeit anfragen.

Article pas plus en collection. Disponibilité en stock à vérifier.

En eliminación. Consultar disponibilidad.

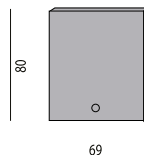

PANNELLO PORTA TV IN LEGNO CM. 72
Wooden board for flat TV cm. 72

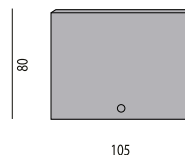

PANNELLO PORTA TV IN LEGNO CM. 108
Wooden board for flat TV cm. 108

ESSENZE | *Essences*



Ciliegio naturale
Natural Chery



Ciliegio
Cherry
tinto/stained american



Frassino Naturale
Natural Ash



Frassino
Ash
tinto/stained wengé

LACCATO OPACO PORO APERTO | *Matt lacquered open pore*



Bianco
White
(RAL 9016)



Avorio
Ivory
(RAL 1013)

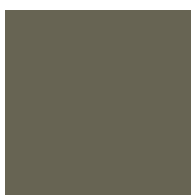

Argilla
Mud
(RAL 7006)



Piombo
Lead
(NCS S5005G20Y)



Cioccolato
Chocolate
(RAL 8019)

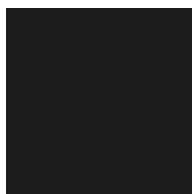

Nero
Black
(RAL 9005)



Granata
Garnet red
(NCS S4050Y90R)

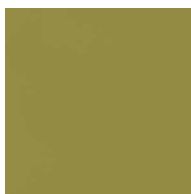

Pistacchio
Pistachio green
(PANTONE 5825)



Avio
Aviation blue
(PANTONE 5415)