











Bepop

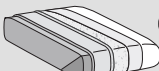

	Seduta - Seat	Schienali - Backrests	Struttura - Structure	
Rivestimento Upholstering (11)	Sfoderabile Removable  			
	Non sfoderabile Not removable —			
Imbottiture Padding (4-5-6-7-8-9-10)	  D.35/40kg/m³	 D.21kg/m³	 Pol.espanso	 Optional

INFORMAZIONI TECNICHE

Struttura: 1-2

Masselli portanti in legno di abete e faggio di vari spessori. Fianchi di tamponamento in pannelli di legno multistrati e particelle di legno in classe E1, particolari in pannelli di fibra di legno dura o cellulosa.

Molleggio: 1-3

Schienale in pannelli di fibra di legno dura o cellulosa.

Seduta in nastri elastici di fibra propilenica e lattice incrociati e meccanicamente pretensionati.

Note:

Meccanismo del poggiatesta (12) in acciaio cromato regolabile in 6 posizioni con meccanismo manuale.

TECHNICAL INFORMATION

Structure: 1-2

Solid spruce and beech wood supports in various thicknesses. Buffer side in class E1 plywood and particleboard panels; details in hard or cellulose wood fibre panels.

Springing: 1-3

The back is made of hard or cellulose wooden fibre panels.

Seat with pre-tensioned crossed propylene fibre and latex elastic webbing.

Note:

Chromed steel headrest (12) mechanism 6 positions adjustable with manual mechanism.

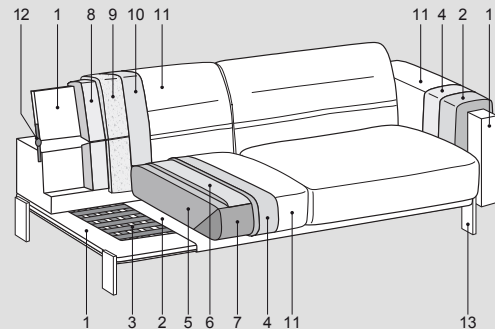
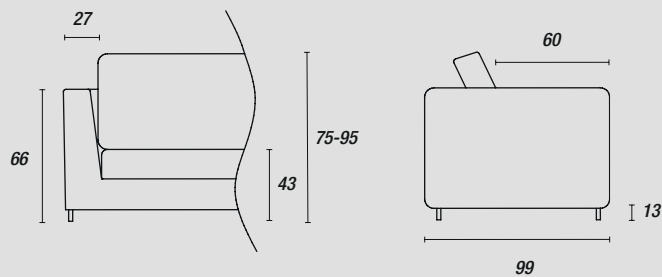

Piedini - Feet:

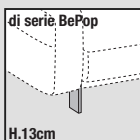

di serie, BePop
Nero (ME09)
Light brown (ME11)