



■ Vers. 064



■ Vers. 200+019



■ Vers. 018+827+049



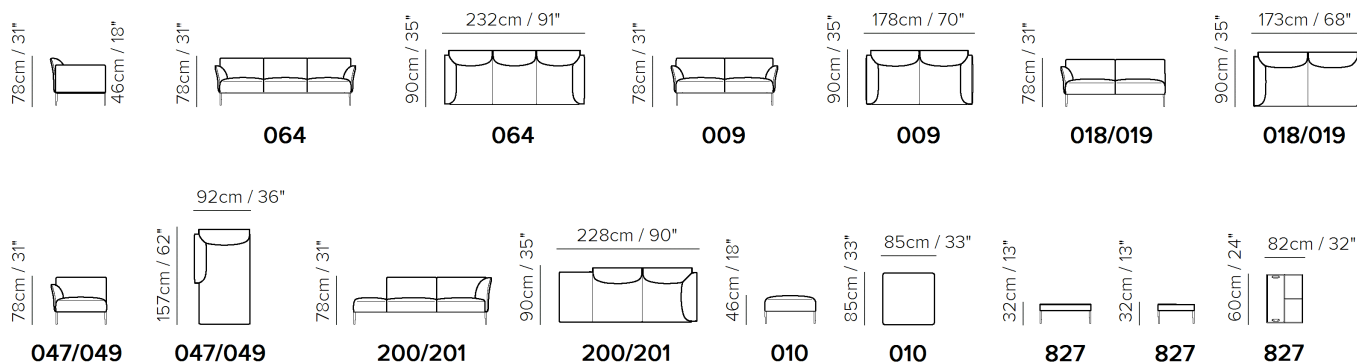

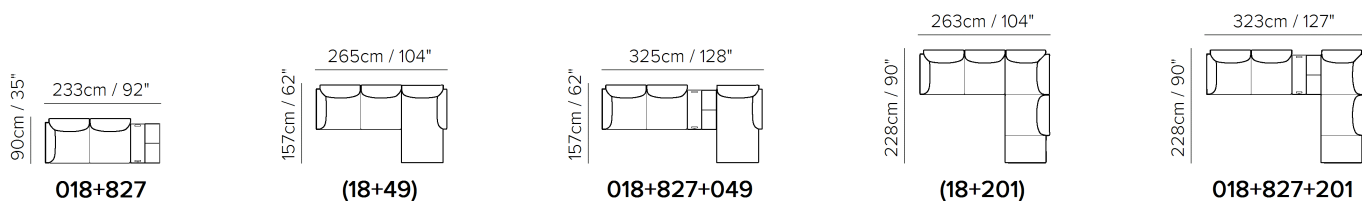

## SCHEMATICS



## COMPOSITION EXAMPLES



## TECHNICAL INFORMATION

	<b>COVERING</b>	Leather <input checked="" type="checkbox"/>	Soft Cover <input checked="" type="checkbox"/>			
	<b>LEGS</b>	Wood <input type="checkbox"/>	Metal <input type="checkbox"/>	Plastic <input type="checkbox"/>	Castors <input type="checkbox"/>	Upholstered <input type="checkbox"/>
	<b>FILLING</b>	Arms <input type="checkbox"/> Fiber <input checked="" type="checkbox"/> Foam <input type="checkbox"/> Feather/Fiber Mix <input type="checkbox"/> Feather	Seat cushion <input type="checkbox"/> Fiber <input checked="" type="checkbox"/> Foam <input type="checkbox"/> Feather/Fiber Mix <input type="checkbox"/> Feather	Back cushion <input type="checkbox"/> Fiber <input checked="" type="checkbox"/> Foam <input type="checkbox"/> Feather/Fiber Mix <input type="checkbox"/> Feather		
	<b>COMFORT</b>	Standard Comfort <input checked="" type="checkbox"/>	Firm Comfort <input type="checkbox"/>			
	<b>FUNCTION</b>	Bed <input type="checkbox"/>	Electric motion <input type="checkbox"/>	Motion <input type="checkbox"/>	Recliner <input type="checkbox"/>	Sliding <input type="checkbox"/>
	<b>OPTIONS</b>	Nails <input type="checkbox"/>	Removable <input type="checkbox"/>	Contrast Stitching <input type="checkbox"/>		
	<b>WRINKLES &amp; VISUAL APPEARANCE</b>	Low <input checked="" type="checkbox"/>	Medium <input type="checkbox"/>	High <input type="checkbox"/>		

## WRINKLES & VISUAL APPEARANCE

Due to a combination of the elasticity of the covering, the nature of the interior construction and the design for comfortability of the product, the model may exhibit differing levels of wrinkles.



Low



Medium



High

The models need to be dressed on a regular basis to maintain their appearance and the wrinkles should not be considered as a manufacturing defect, but a natural characteristic of the product.

## NOTES

- In leather the model is available starting from cat. 25 (Status).
- Available in Byborre covering, designed by Dutch textile innovation studio BORRE, a yarn that combines very high quality wool and recycled PES with 3D pattern and available in several colours.
- Wide seats despite general small scale of model thanks to slim armrest.
- Absolute comfortable seat cushions thanks to a new polyurethane foam with high density (50).
- Version 827: Table top in black ash wood combined with the same metal base of the sofa in glossy black
- Internal wooden frame
- Glossy black finishing (FT71) open base design gives a feeling of lightness to the model.

NOTES

---