



■ Vers. 064+073



■ Vers. 064+073+827



■ Vers. 064



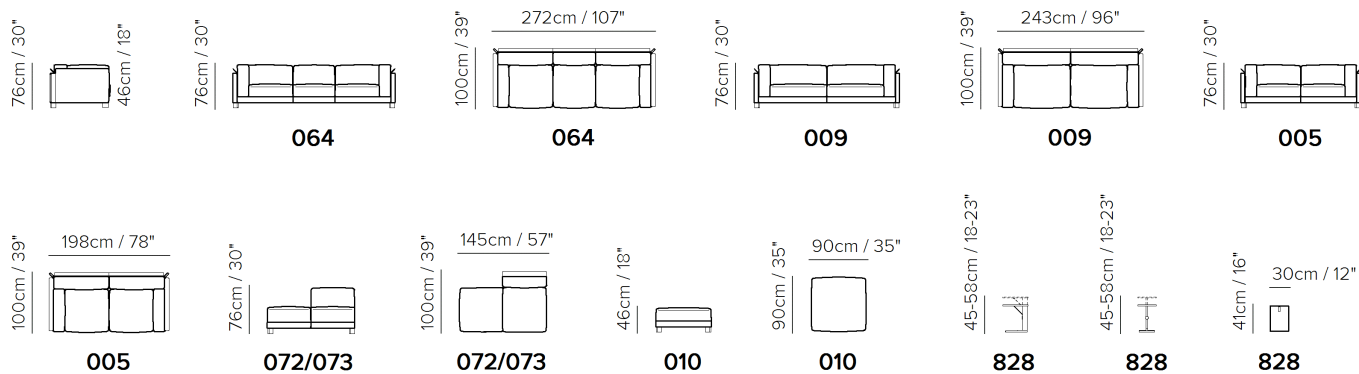

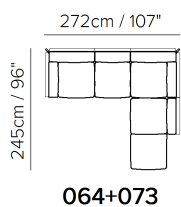

SCHEMATICS



COMPOSITION EXAMPLES



TECHNICAL INFORMATION

	COVERING	Leather <input checked="" type="checkbox"/>	Soft Cover <input checked="" type="checkbox"/>				
	LEGS	Wood <input type="checkbox"/>	Metal <input type="checkbox"/>	Plastic <input type="checkbox"/>	Castors <input type="checkbox"/>	Upholstered <input type="checkbox"/>	
	FILLING	Arms <input type="checkbox"/>	Fiber <input type="checkbox"/> Foam <input type="checkbox"/> Feather/Fiber Mix <input type="checkbox"/> Feather <input type="checkbox"/>	Seat cushion <input type="checkbox"/>	Fiber <input type="checkbox"/> Foam <input type="checkbox"/> Feather/Fiber Mix <input type="checkbox"/> Feather <input type="checkbox"/>	Back cushion <input type="checkbox"/>	Fiber <input type="checkbox"/> Foam <input type="checkbox"/> Feather/Fiber Mix <input type="checkbox"/> Feather <input type="checkbox"/>
	COMFORT	Standard Comfort <input checked="" type="checkbox"/>	Firm Comfort <input type="checkbox"/>				
	FUNCTION	Bed <input type="checkbox"/>	Electric motion <input type="checkbox"/>	Motion <input type="checkbox"/>	Recliner <input type="checkbox"/>	Sliding <input type="checkbox"/>	
	OPTIONS	Nails <input type="checkbox"/>	Removable <input type="checkbox"/>	Contrast Stitching <input type="checkbox"/>			
	WRINKLES & VISUAL APPEARANCE	Low <input checked="" type="checkbox"/>	Medium <input type="checkbox"/>	High <input type="checkbox"/>			

WRINKLES & VISUAL APPEARANCE

Due to a combination of the elasticity of the covering, the nature of the interior construction and the design for comfortability of the product, the model may exhibit differing levels of wrinkles.



The models need to be dressed on a regular basis to maintain their appearance and the wrinkles should not be considered as a manufacturing defect, but a natural characteristic of the product.

NOTES

- With code 3231 it is possible to order the model in mix: Back and lateral panels in saddle leather; Seat cushions, back cushions and arms in Byborre, fabric or leather (starting from cat. 25 Status).
- With code V231 it is possible to order the model all in leather (starting from cat.25 Status).
- Available in Byborre covering, designed by Dutch textile innovation studio BORRE, a yarn that combines very high quality wool and recycled PES with 3D pattern and available in several colours.
- Back and side panels covered in saddle leather available in 3 colors: ice white, taupe, and dark brown. Inside them there is a molded plywood bonded with a layer of polyurethane.
- Ver 827 is the optional wooden desk element with metal hooks (same finish as the feet) that can be integrated into the back of the frame. Cable duct in the frame to hide the computer wire.
- Ver 828 integrates a height-adjustable wooden side table in natural ash wood.

NOTES
