

Denver



SOVET

ITALIA

Denver

Design by Guido Porcellato

La collezione di specchiere Denver si arricchisce con le nuove cornici in ceramica. Le diverse tonalità di specchio centrale proposte, dall'extrachiaro al bronzo fino al fumé permettono di creare combinazioni uniche che arredano gli interni in armonia con diversi stili e ambienti.

The Denver mirrors collection embraces the new ceramic frames. The different mirror shades available for the central mirror, from the extralight to the bronzed and the smoked, allow to create unique combinations that furnish the interiors in harmony with different styles and environments.

Gallery

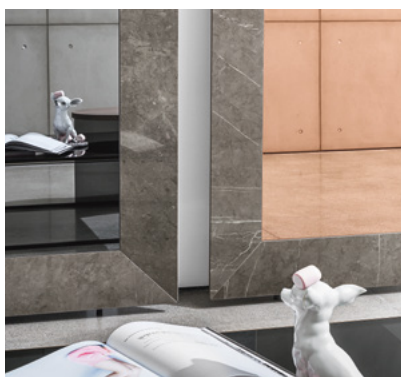
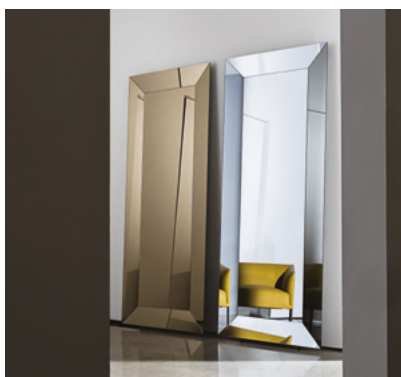

Specchiera con telaio in alluminio per attacco verticale/orizzontale o con appoggio a terra.
Specchio centrale disponibile nelle finiture extrachiaro, fumé o bronzo. Cornice perimetrale
disponibile in vetro laccato, specchio o ceramica, varie finiture. Optional: retroilluminazione
a led.

Floor or horizontal/vertical hanging mirror with aluminium structure. Central mirror available
in extralight, smoked or bronzed finish. Frame available in lacquered glass, mirror or ceramic,
various finishes. Available also with led lighting on the back.

Models & Dimensions

90x90
120x120
200x200

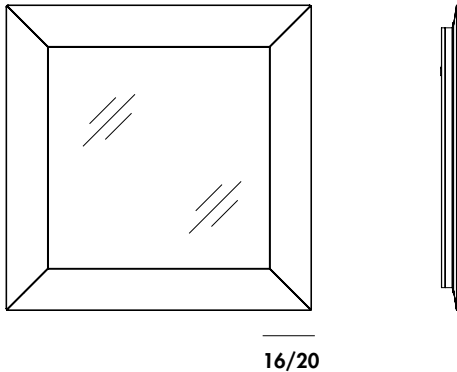

120x90
160x65
160x90
180x90
220x90

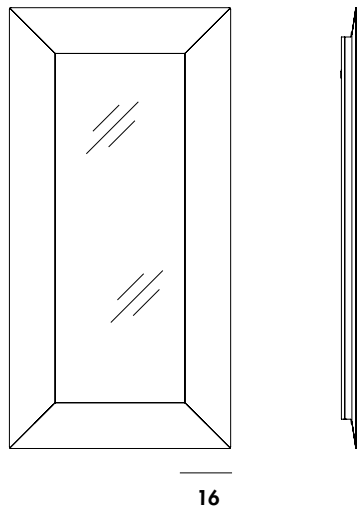

Finiture cornice / Frame finishes

Vetro laccato/ Lacquered glass

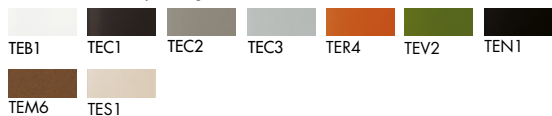

Vetro acidato/ Frosted glass

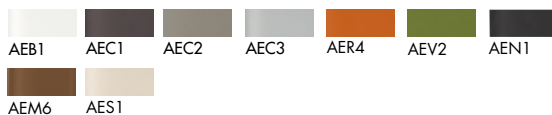

Ceramica CE1/Ceramic CE1

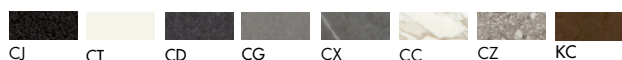

Ceramica CE2/Ceramic CE2

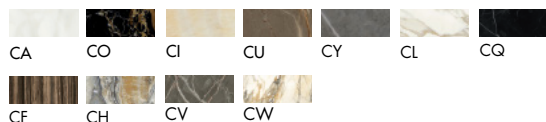

Specchio/Mirror



Specchio acidato/Mirror finishes



Specchio centrale / Central mirror

Specchio/Mirror



Led light 3000 K

*
Gli specchi oro e rosa potrebbero presentare delle piccole imperfezioni dovute alle caratteristiche tecniche del materiale. Non possono essere utilizzati in luoghi umidi. Pulire solo con panni asciutti.

Gold and rose mirrors could have small imperfections due to the particular technical characteristics of the material. We recommend not to use them in damp areas. Clean only with a dry cloth.

* *
Nella versione a led, specificare se attacco verticale o orizzontale.
In the led version, please advise if vertical or horizontal hanging.