

LEVANTE

design Marco Spatti

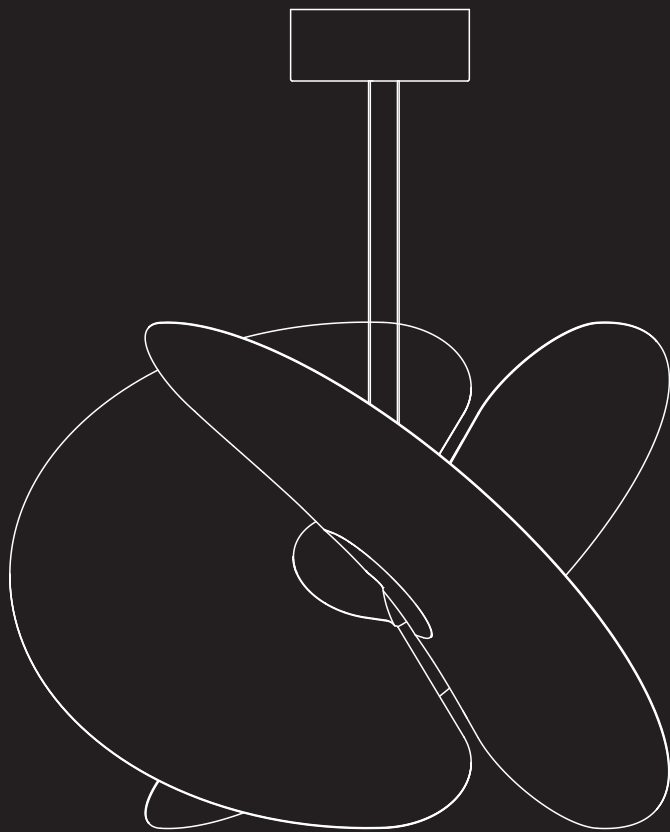

**LUCE
PLAN**

A06



A06/1T - A06/2T

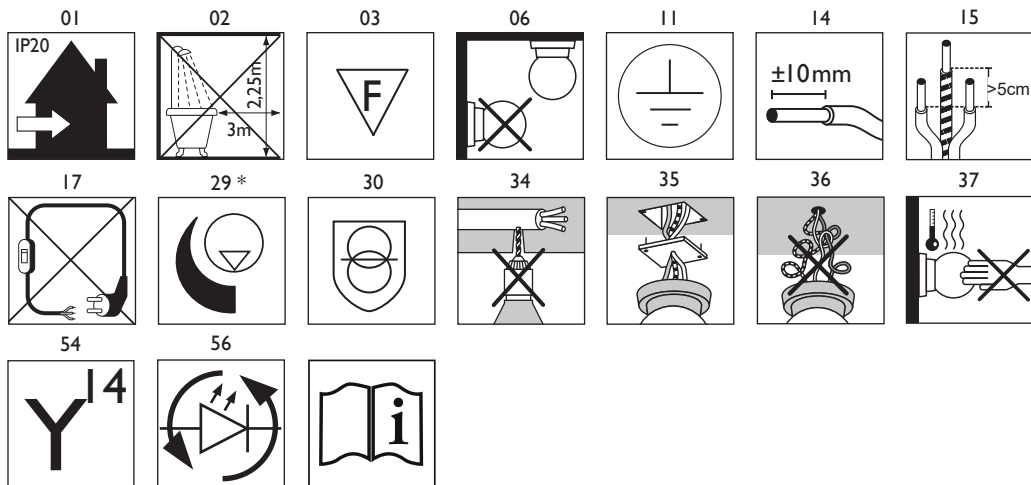

29* Levante drivers are suitable for use with Trailing edge dimm

A06/1D - A06/2D

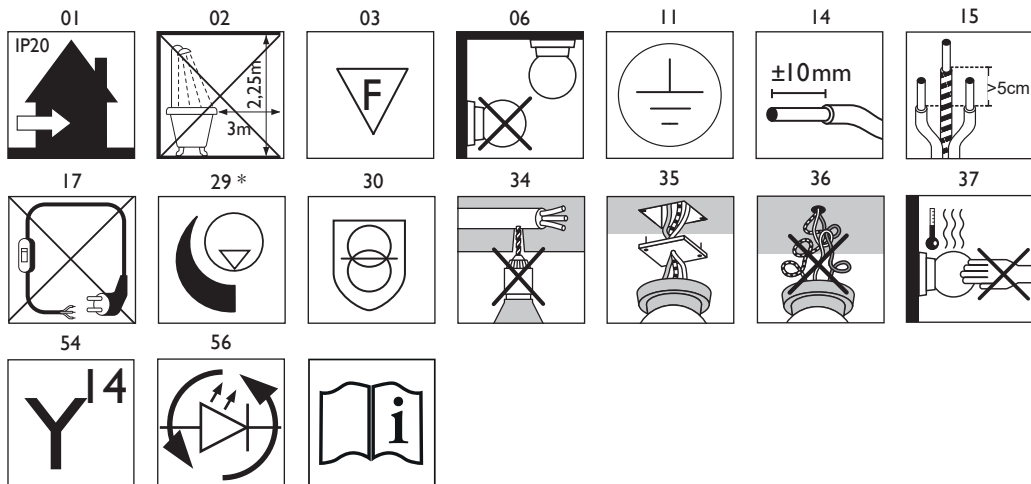

29* Levante drivers are suitable for use with DALI - Push dimm

A06/1D
A06/1T
+
A06C1

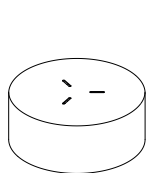
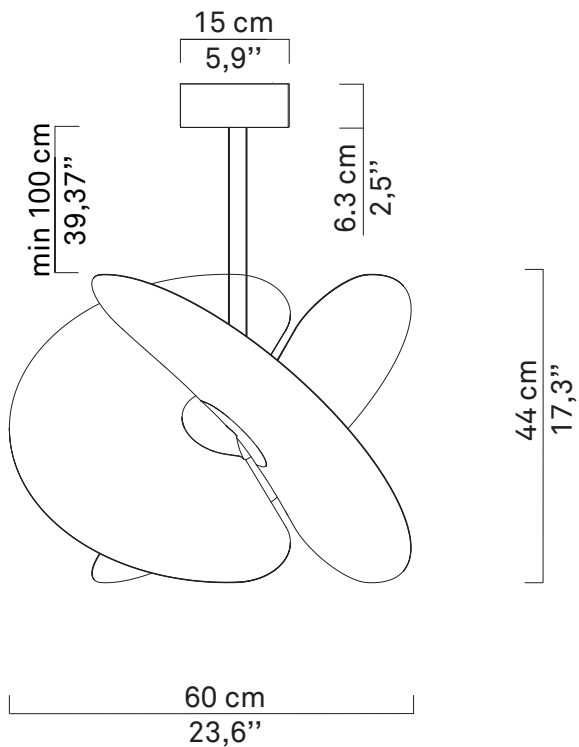

X1

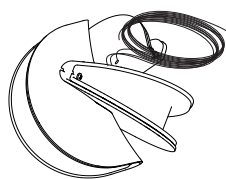

X1



X1

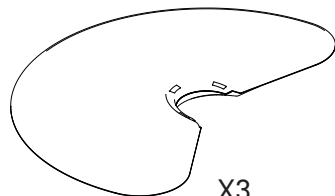

X3

kg 2,5 kg

lb 5,51 lb

A06/2D
A06/2T
+
A06C2

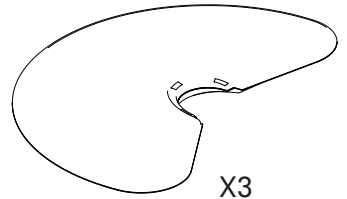
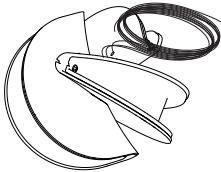
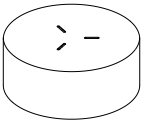
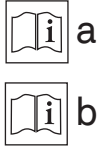
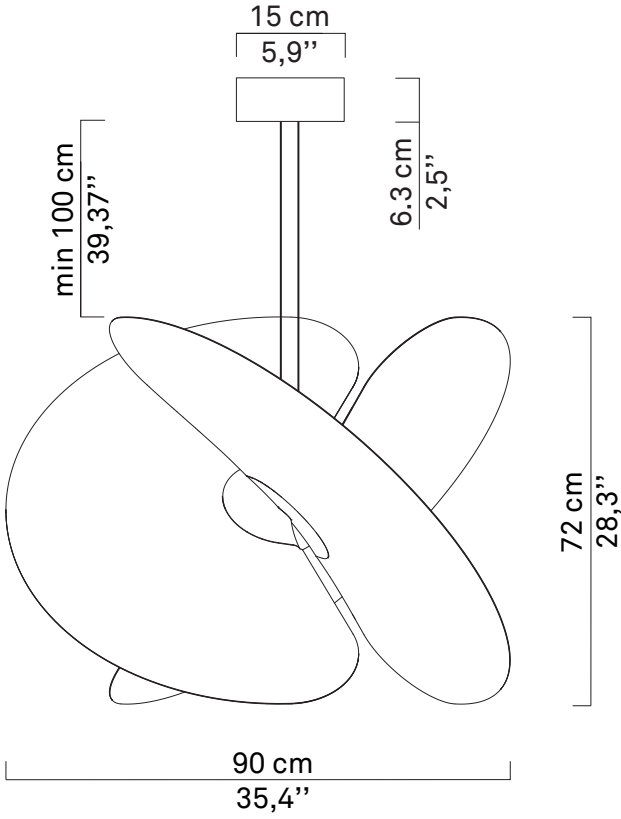

kg 4,2 kg

lb 9,3 lb

1 | 1.1

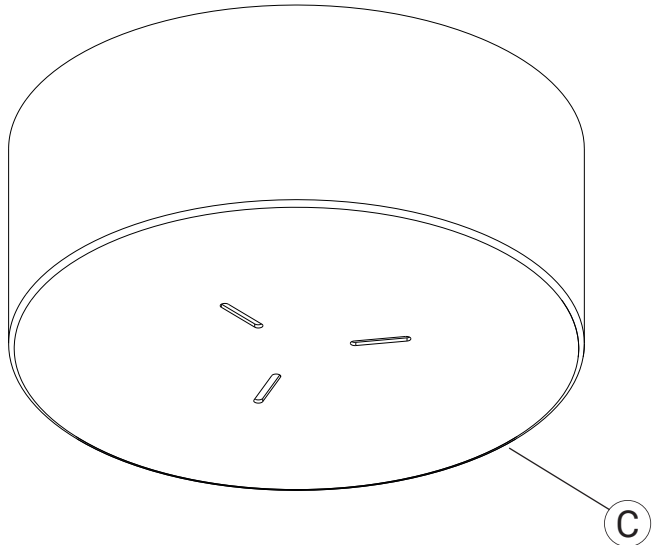
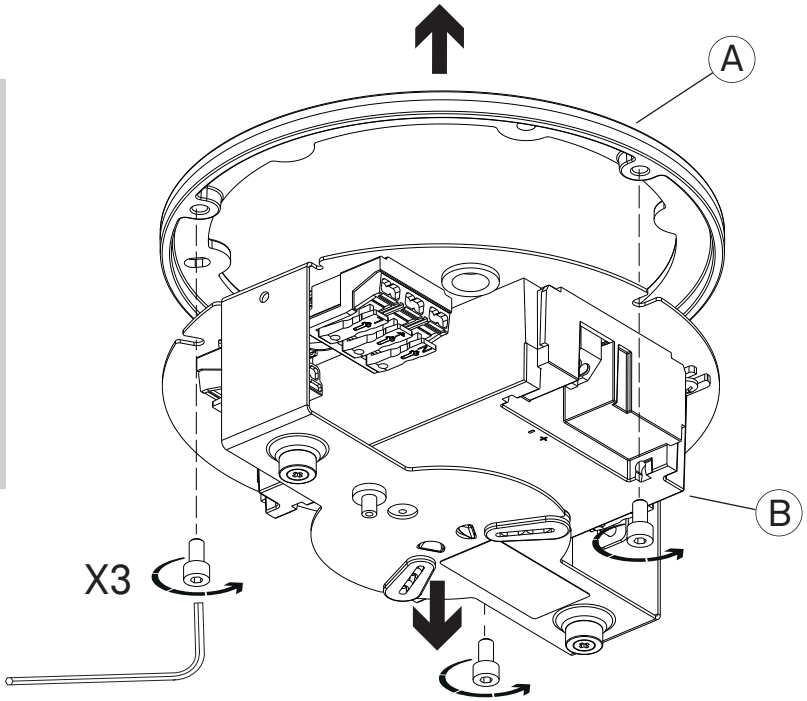
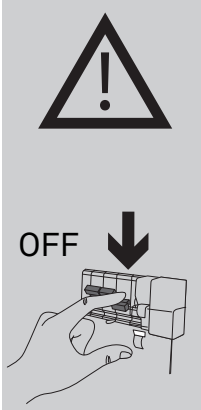

1.2

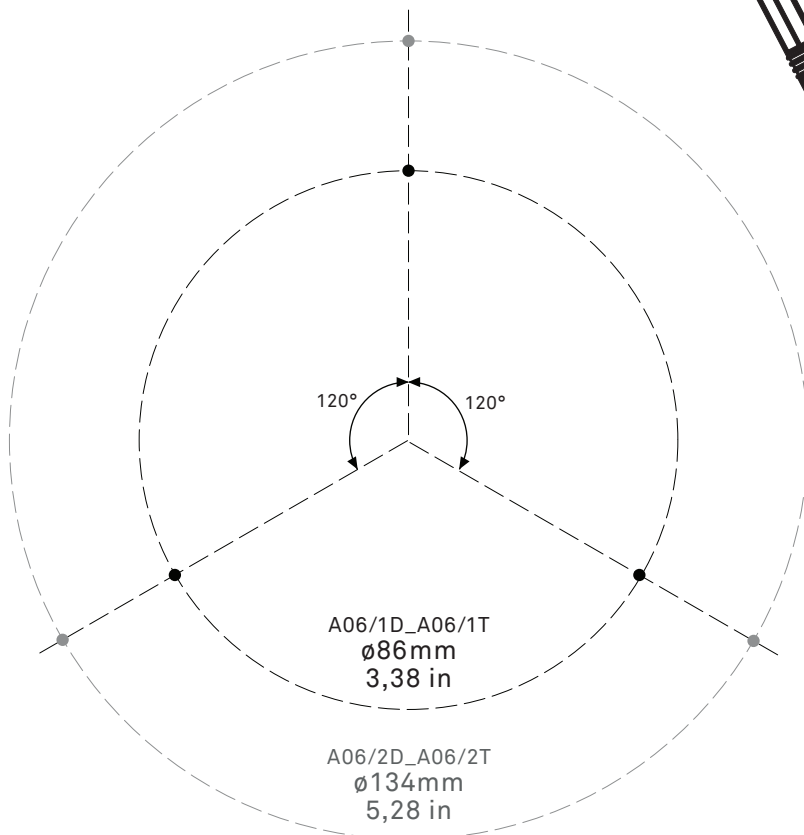
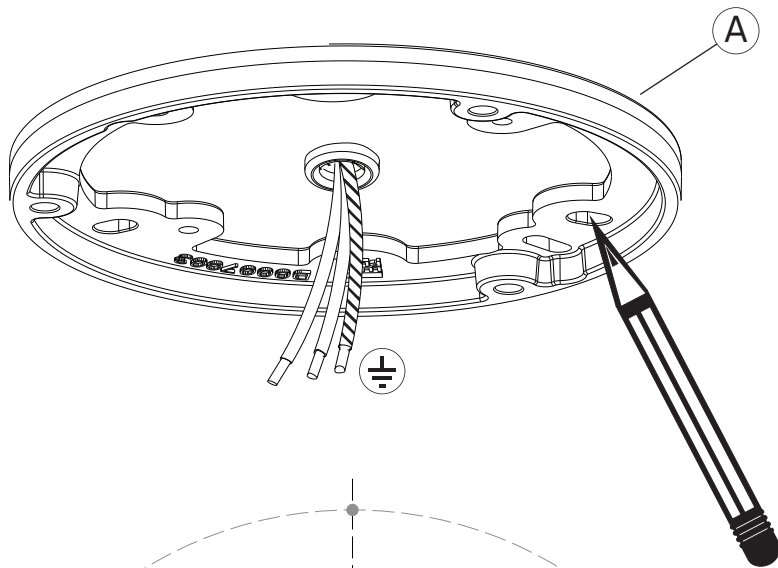

1.3

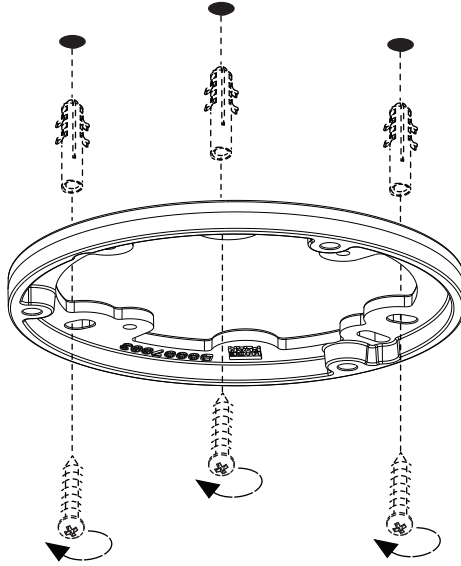

1.4

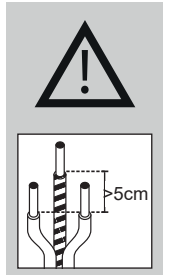
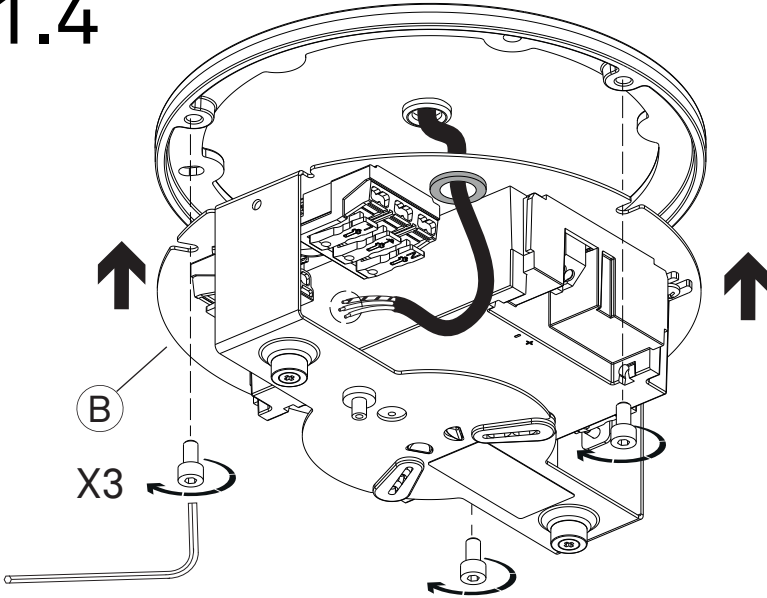

1.5

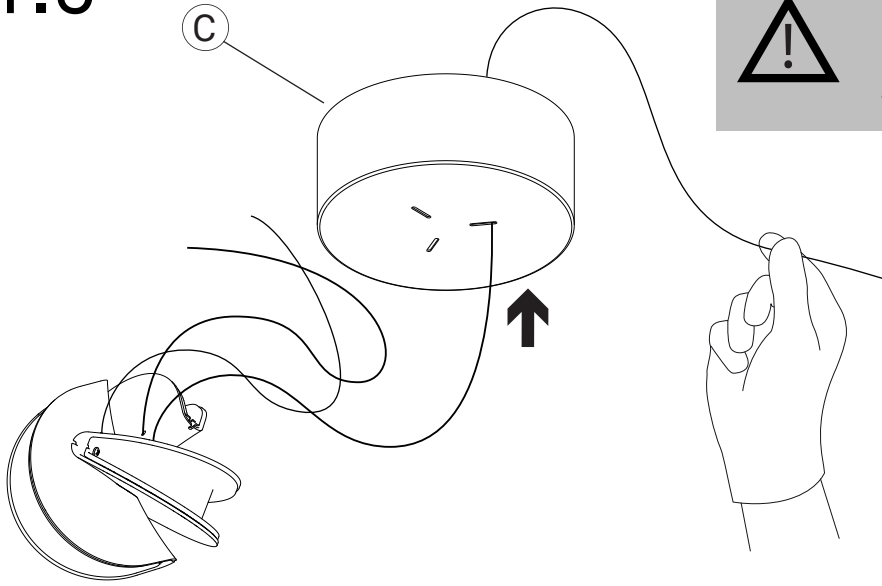

1.6

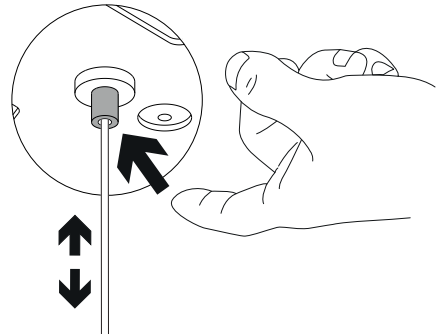
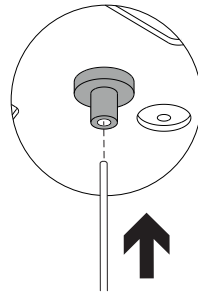
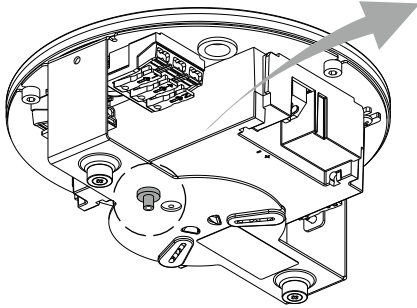

IT solo cavo in acciaio

EN steel wire only

DE nur stahlkabel

FR seulement câble en acier

ES cable de acero solamente



1.8

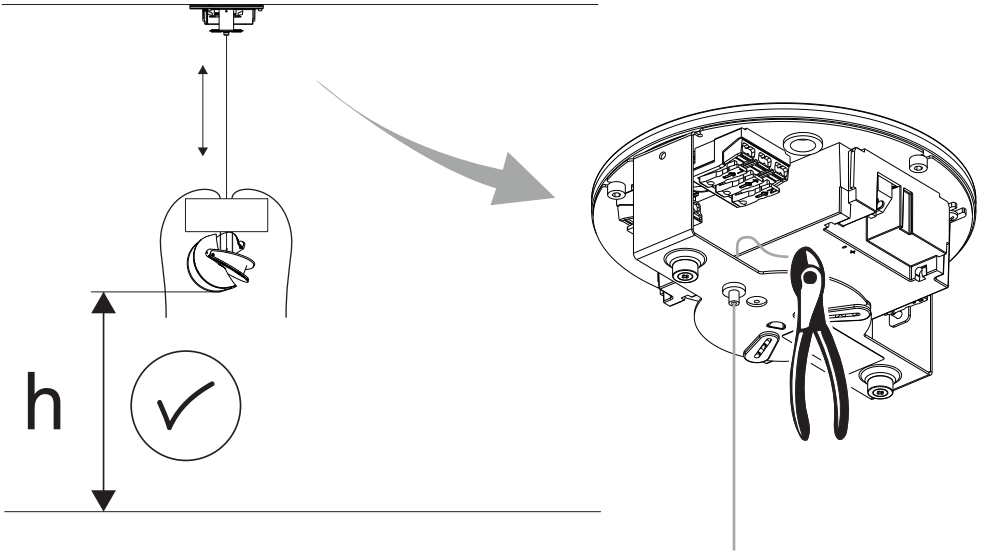

1.9

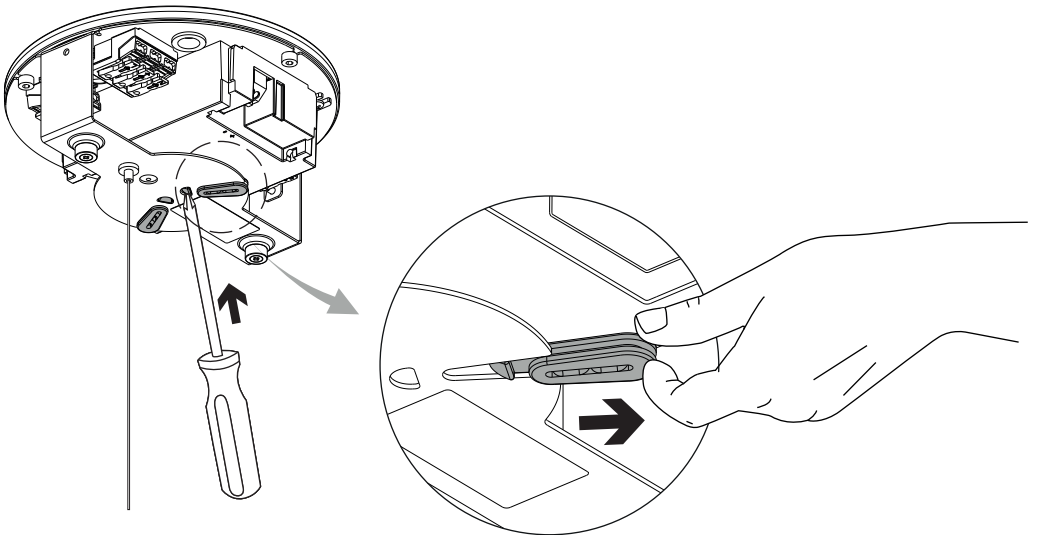

1.10

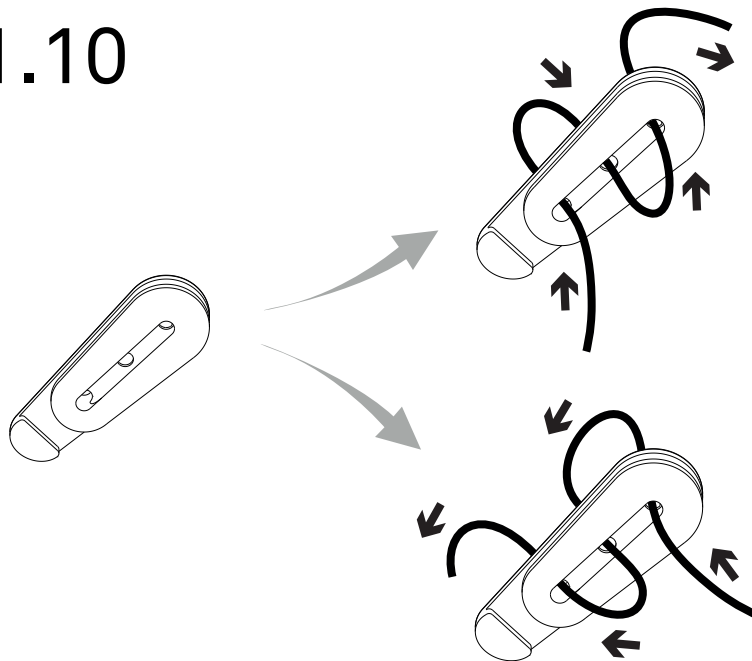

A06/1D
A06/1T

A06/2D
A06/2T

1.11

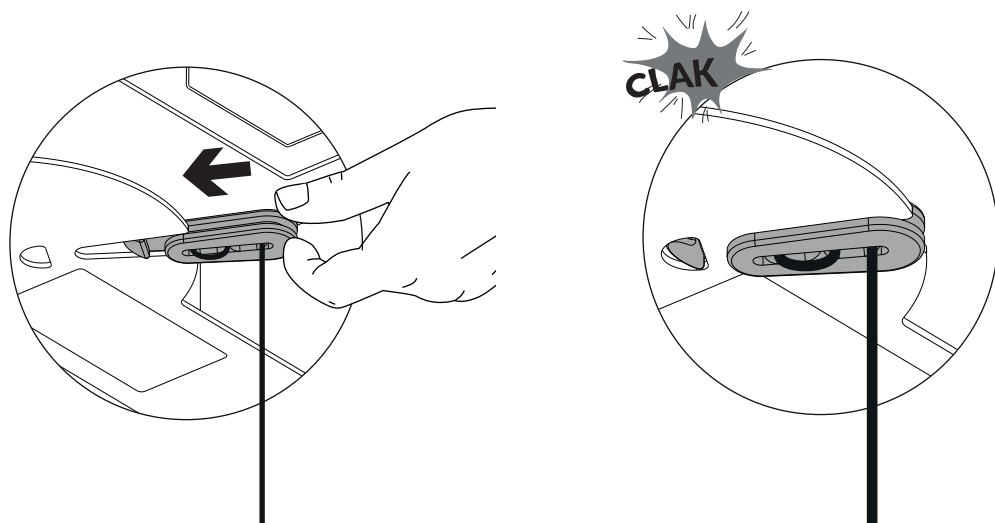

1.12

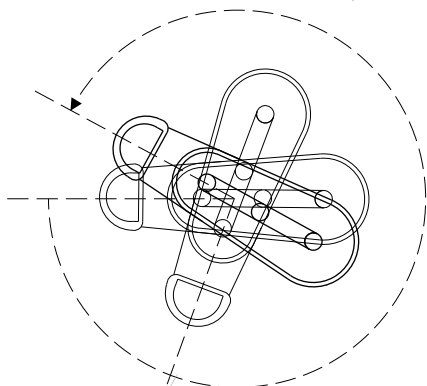
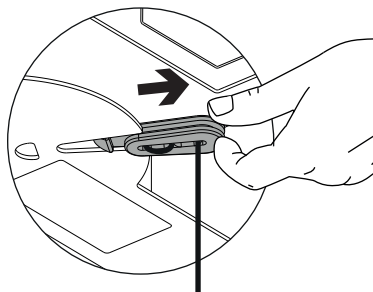
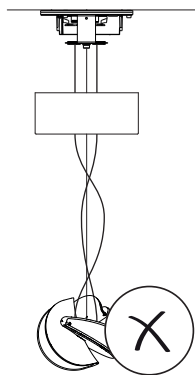

IT ruotare in senso orario o antiorario

EN rotate clockwise or counterclockwise



DE um im Uhrzeigersinn oder gegen den Uhrzeigersinn drehen

FR tourner dans le sens horaire ou antihoraire

ES gírelo en el sentido del reloj o contrarreloj

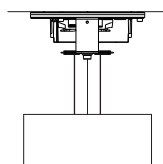
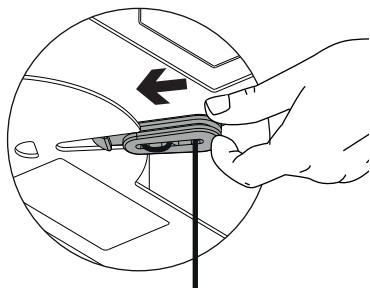

2 A06/1T _ A06/2T

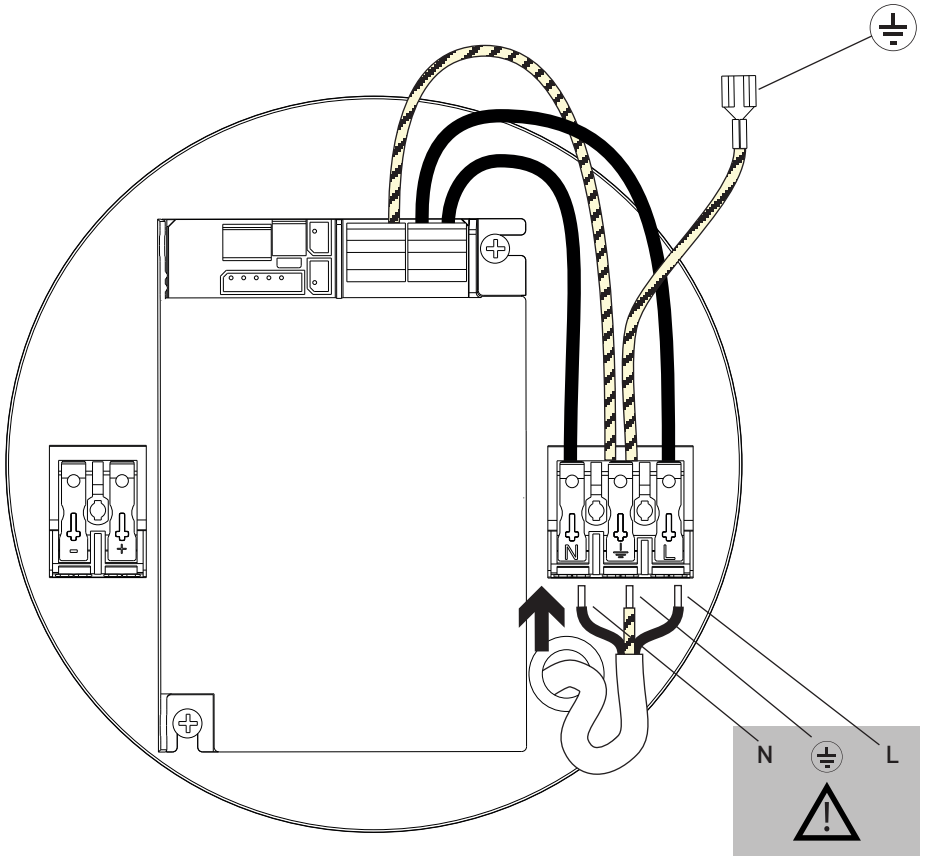

A06/1D _ A06/2D

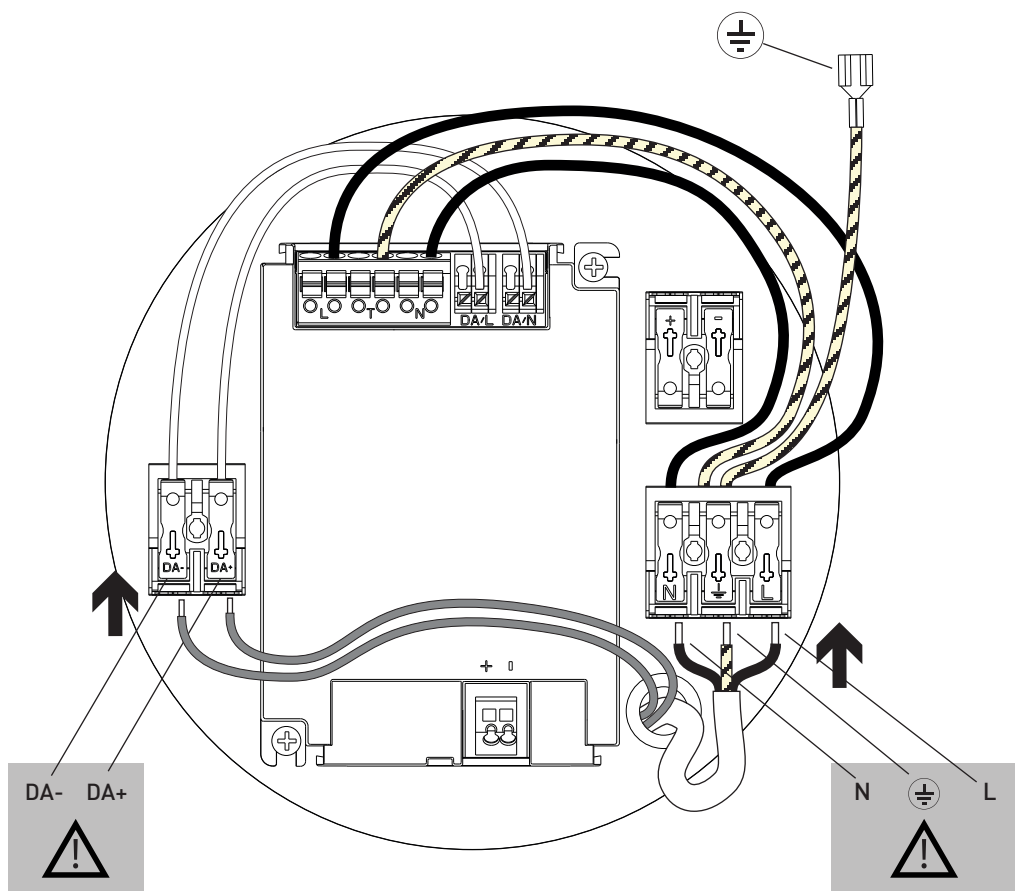

A06/1D _ A06/2D

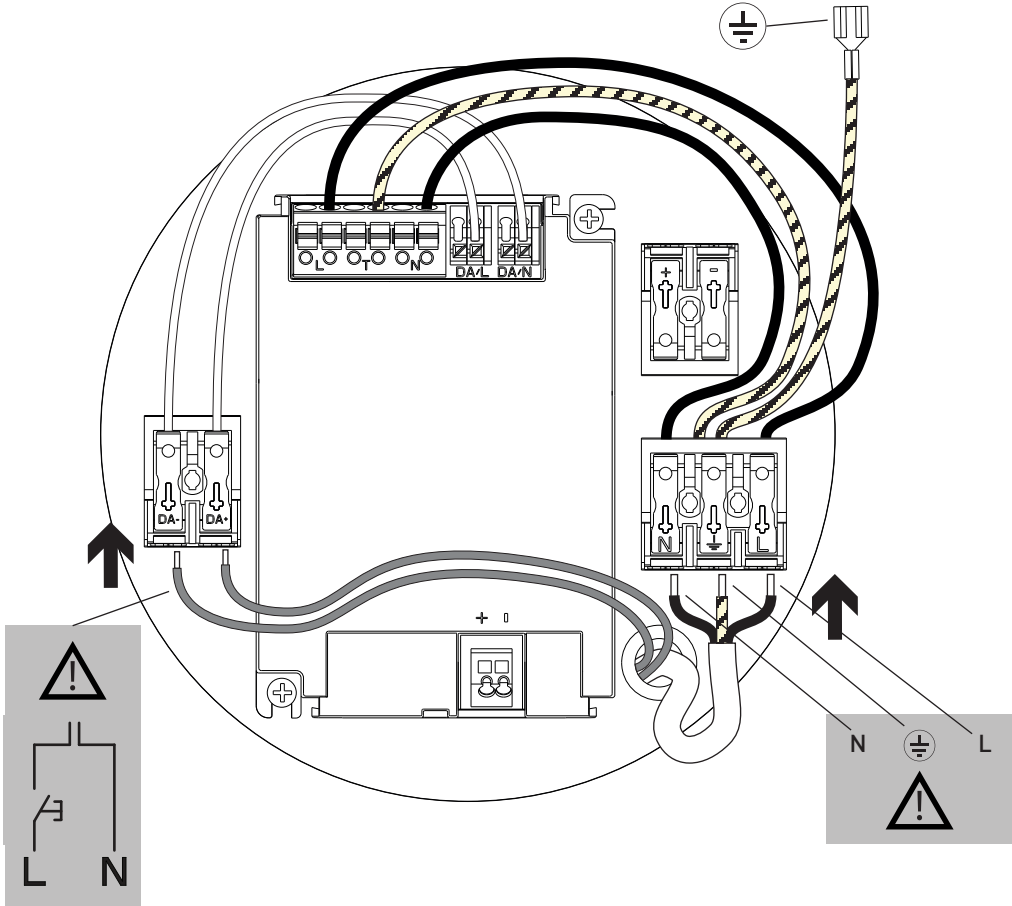
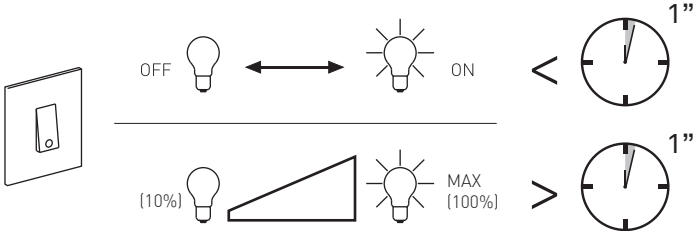

3 | 3.1

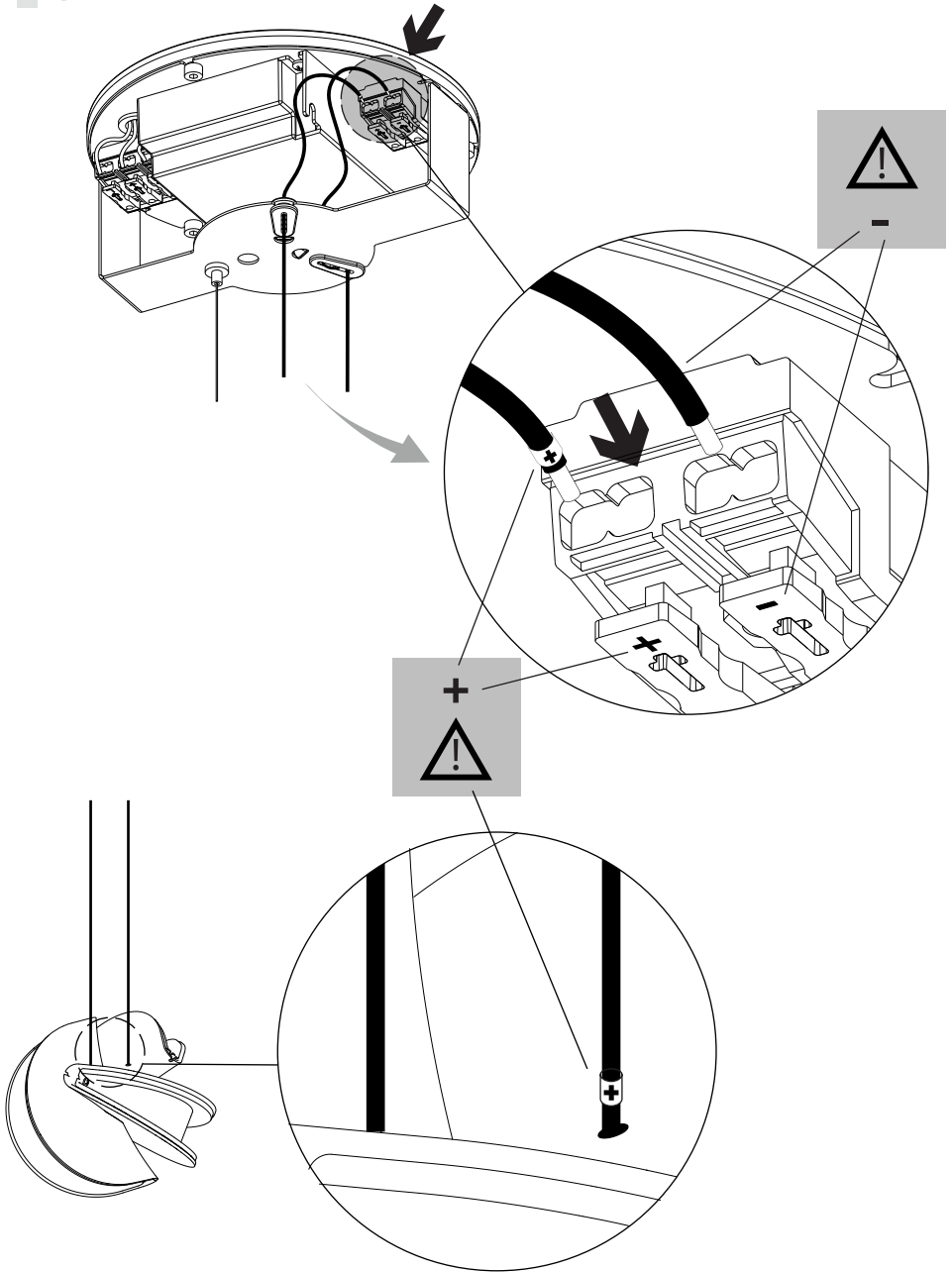

3.2

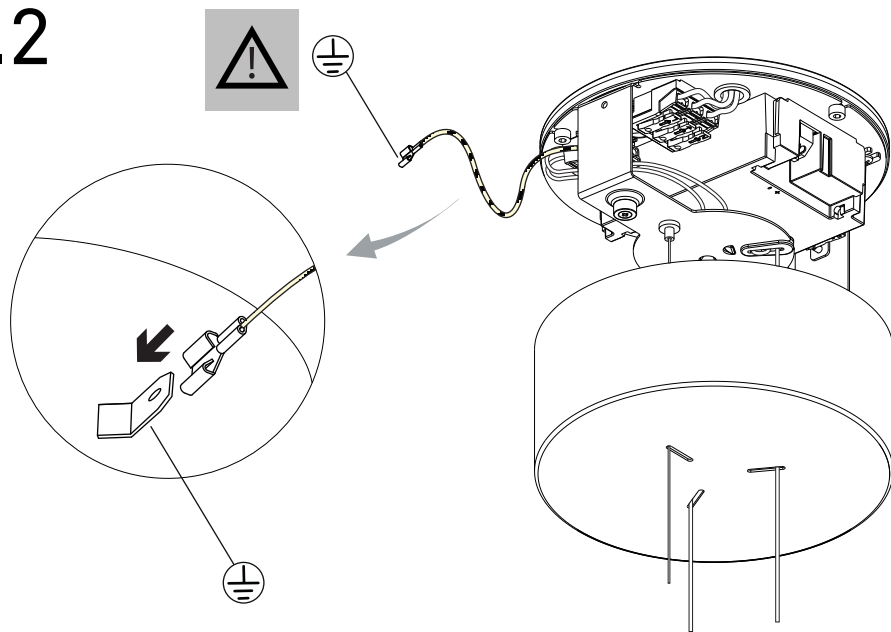

3.3

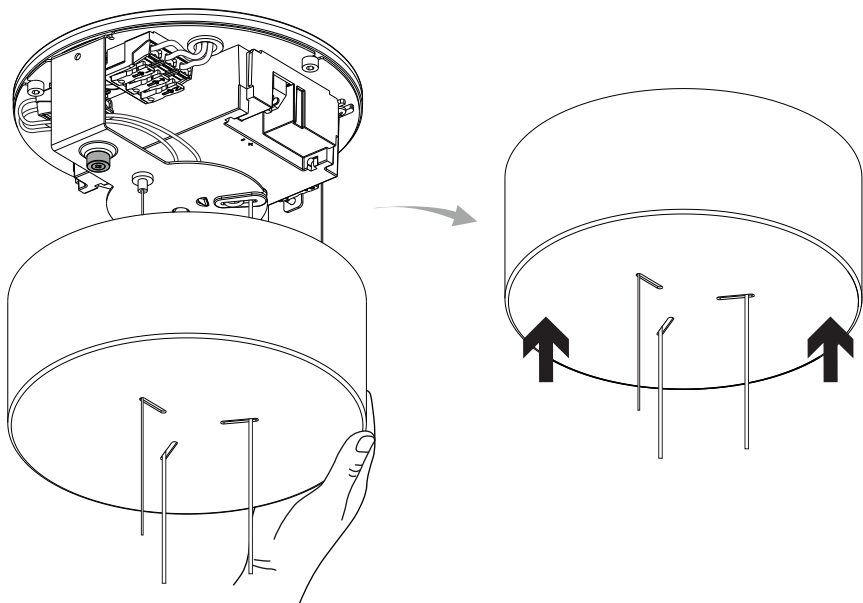

4 | 4.1

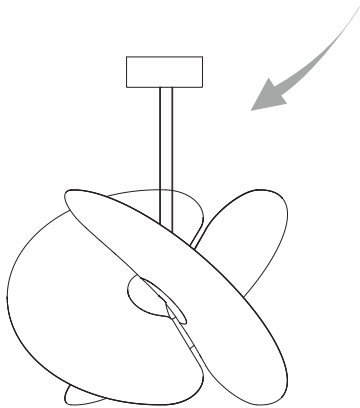
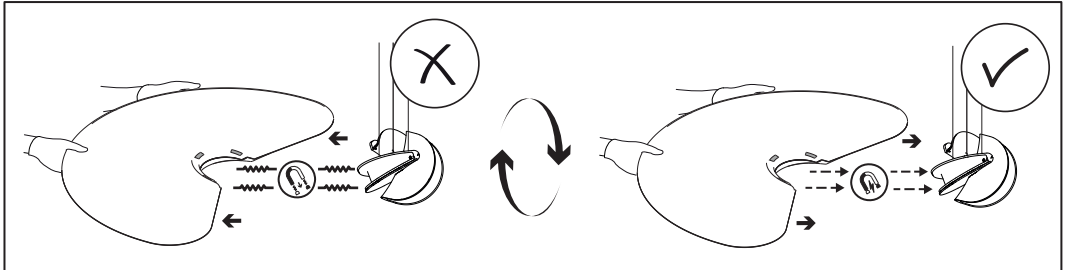
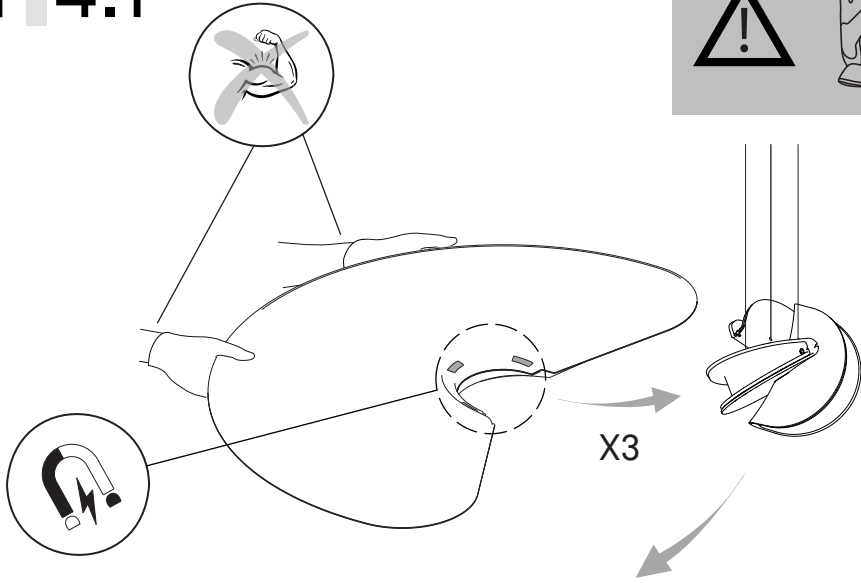

ECODESIGN

SYMBOL LEGEND

LEGENDA DEI SIMBOLI

ERLÄUTERUNG DER SYMBOLE

LEGENDE DES SYMBOLES

LEYENDA DE LOS SIMBOLOS



Replaceable light source by end-user
 Fonte luminosa sostituibile dal cliente finale
 Austauschbare Lichtquelle durch den Endanwender
 Source lumineuse remplaçable par l'utilisateur final
 Fuente de luz reemplazable por el usuario final

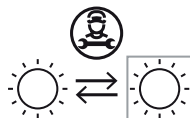

Replaceable light source by a professional
 Fonte luminosa sostituibile da un professionista
 Austauschbare Lichtquelle durch einen Fachmann
 Source lumineuse remplaçable par un professionnel
 Fuente de luz reemplazable por un profesional



Replaceable (LED only) light source by end-user
 Fonte luminosa (solo LED) sostituibile dal cliente finale
 Austauschbare (nur LED) Lichtquelle durch den Endanwender
 Source lumineuse remplaçable (LED uniquement) par l'utilisateur final
 Fuente de luz reemplazable (sólo LED) por el usuario final



Replaceable (LED only) light source by a professional
 Fonte luminosa (solo LED) sostituibile da un professionista
 Austauschbare (nur LED) Lichtquelle durch einen Fachmann
 Source lumineuse remplaçable (LED uniquement) par un professionnel
 Fuente de luz reemplazable (sólo LED) por un profesional



Non-replaceable light source
 Fonte luminosa non sostituibile
 Nicht austauschbare Lichtquelle
 Source lumineuse non remplaçable
 Fuente de luz no reemplazable

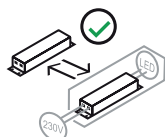

Replaceable control gear by an end-user
 Unità di alimentazione sostituibile dal cliente finale
 Austauschbares Vorschaltgerät durch einen Endanwender
 Pièce d'alimentation remplaçable par l'utilisateur final
 Unidad de alimentación reemplazable por el usuario final

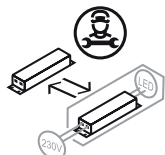

Replaceable control gear by a professional
 Unità di alimentazione sostituibile da un professionista
 Austauschbares Vorschaltgerät durch einen Fachmann
 Pièce d'alimentation remplaçable par un professionnel
 Unidad de alimentación reemplazable por un profesional

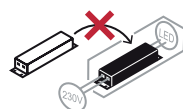

Non-replaceable control gear
 Unità di alimentazione non sostituibile
 Nicht austauschbares Vorschaltgerät
 Pièce d'alimentation non remplaçable
 Unidad de alimentación no reemplazable



5

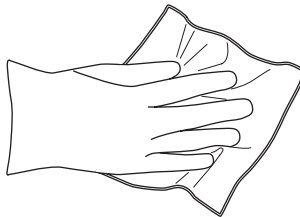
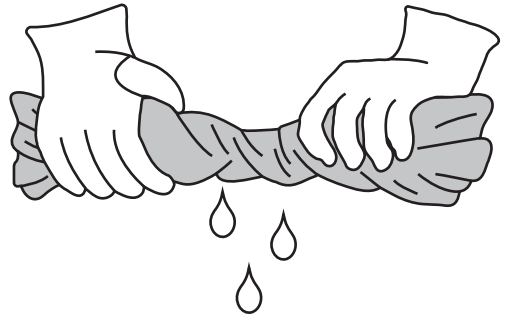
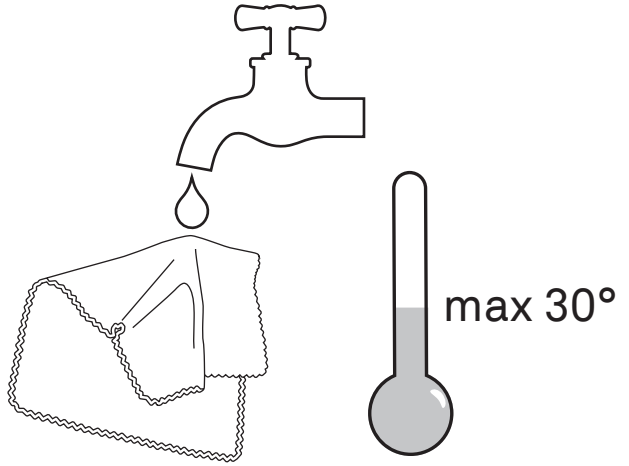
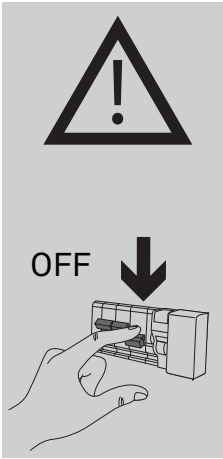



www.luceplan.com

A060IC0001