

# SHAN

## Design Ludovica+Roberto Palomba

27 elementi componibili + 5 elementi singoli + 1 pouf.  
 8 elementi con letto per uso occasionale.  
 Struttura in legno multistrato di pioppo e betulla con cinghie elastiche con tampone in poliuretano espanso, rivestito in fibra accoppiata con maglia.  
 Cuscini di seduta in poliuretano espanso a quote differenziate, rivestiti in fibra accoppiata cotone.  
 Cuscini schienale, poggiatesta e braccioli in piuma e conforel rivestiti in cotone.  
 Piedini in metallo verniciati a polvere, con puntale antiscivolo.  
 Elementi con letto provvisti di meccanismo a 3 pieghe, rete elettrosaldata, materasso in espanso HR30 spessore 6 cm. circa  
 Elementi rivestiti in tessuto completamente sfoderabili; elementi rivestiti in pelle con cuscineria sfoderabile e struttura non sfoderabile.

27 éléments composables + 5 éléments indépendants + 1 pouf.  
 8 éléments munis de lit pour des occasions imprévues.  
 Structure en bois multicouche de peuplier et bouleau, courroies élastiques, tampon en polyuréthane expansé, revêtu de fibre unie à de la maille fine.  
 Coussins de l'assise en polyuréthane expansé, à niveaux différenciés, revêtus de fibre unie à du coton.  
 Coussins du dossier, coussins lombaires et coussins accouider en plume et conforel revêtus coton.  
 Pieds en métal verni à poudre avec système antidérapant.  
 Éléments avec lit avec mécanisme 3 plis, sommier électro-soudé, matelas en expansé HR 30 épaisseur cm. 6 environ.  
 Éléments revêtus de tissu: entièrement déhoussables; éléments revêtus en cuir : coussins entièrement déhoussables, structure non déhoussable.

27 modular elements + 5 individual elements + 1 ottoman.  
 8 elements with bed for occasional use.  
 Wooden frame in multi-layer poplar and multi-layer birch with elastic straps, with pad in expanded polyurethane, fibre covering matched with jersey.  
 Seat cushions in expanded polyurethane, with differentiated density, fibre covering matched with jersey.  
 Backrest cushions, lumbar cushions and armrest cushions in feather and conforel, upholstered in cotton.  
 Feet in metal, powder coated, with anti-skid ferrule. Elements with bed: 3-fold mechanism, electrically welded spring and about 6 cm. thick expanded mattress HR 30. Elements upholstered in completely removable fabric; elements upholstered in leather with cushions having removable covers and structure with non-removable covers.

27 Anbauelemente + 5 Einzelemente + 1 Hocker.  
 8 Elemente verfügbar als Schlafsofa zur gelegentlichen Verwendung.  
 Basisstruktur aus Pappel- und Birke-Multiplexplatte mit elastischen Gurten, Schaumstoffpuffern und Faser/Trikotbezug.  
 Sitzkissen aus Polyurethanschaumstoff zu unterschiedlichen Anteilen und passendem Faser/Baumwollbezug.  
 Rücken-, Lenden- und Armlehnekissen aus Daune und Conforel mit Baumwollbezug. Pulverbeschichtete Metallfüße mit rutschfester Spitze.  
 Elemente mit Bettversion ausgestattet mit Bettmechanismus 3 mal gefaltet, elektrogeschweißten Sprungrahmen und Schaumstoffmatratze HR 30 (Dicke cm. 6 ungefähr).  
 Elemente mit Stoffbezug vollständig abziehbar; Elemente mit Lederbezug mit abziehbaren Polstern und nicht abziehbarem Gestell.

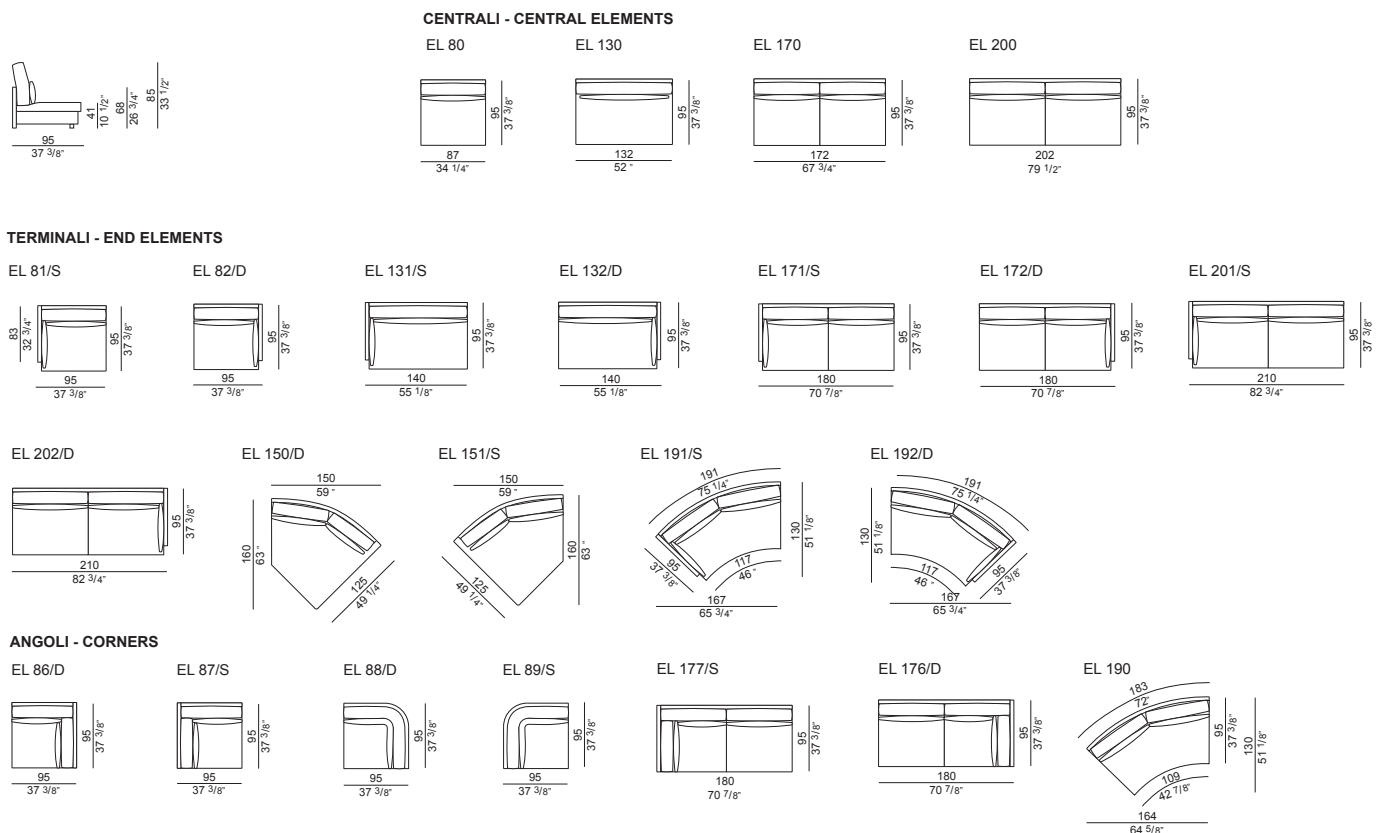

**ANGOLI TERMINALI - CORNER + END ELEMENTS**

EL 174/D

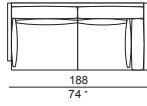

EL 175/S

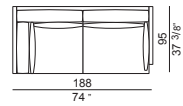

**CHAISE LONGUE**

EL 178/D

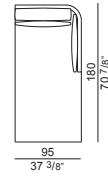

EL 179/S

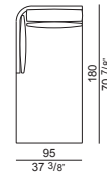

**POUF - OTTOMANS**

EL 85

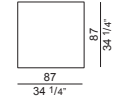

**ELEMENTI FISSI - INDIVIDUAL ELEMENTS**

EL 83

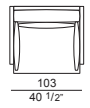

EL 173

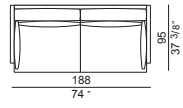

EL 180

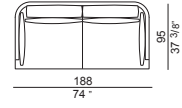

EL 203

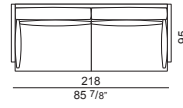

EL 210

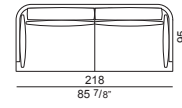

**DIVANO LETTO - SOFA BED**

EL 570

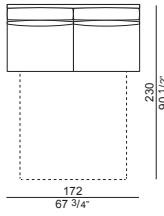

EL 571/S

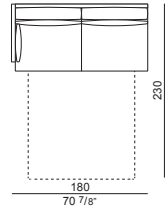

EL 572/D

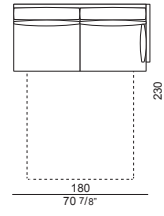

EL 573

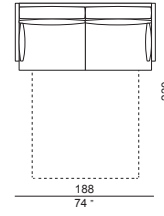

EL 600

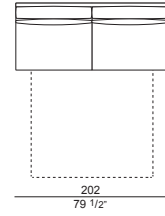

EL 601/S

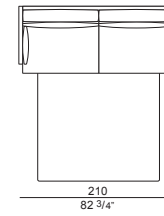

EL 602/D

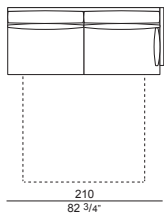

EL 603

