



■ Vers. N00+N25+N02



■ Vers. N46



■ Vers. 000+001+076+002



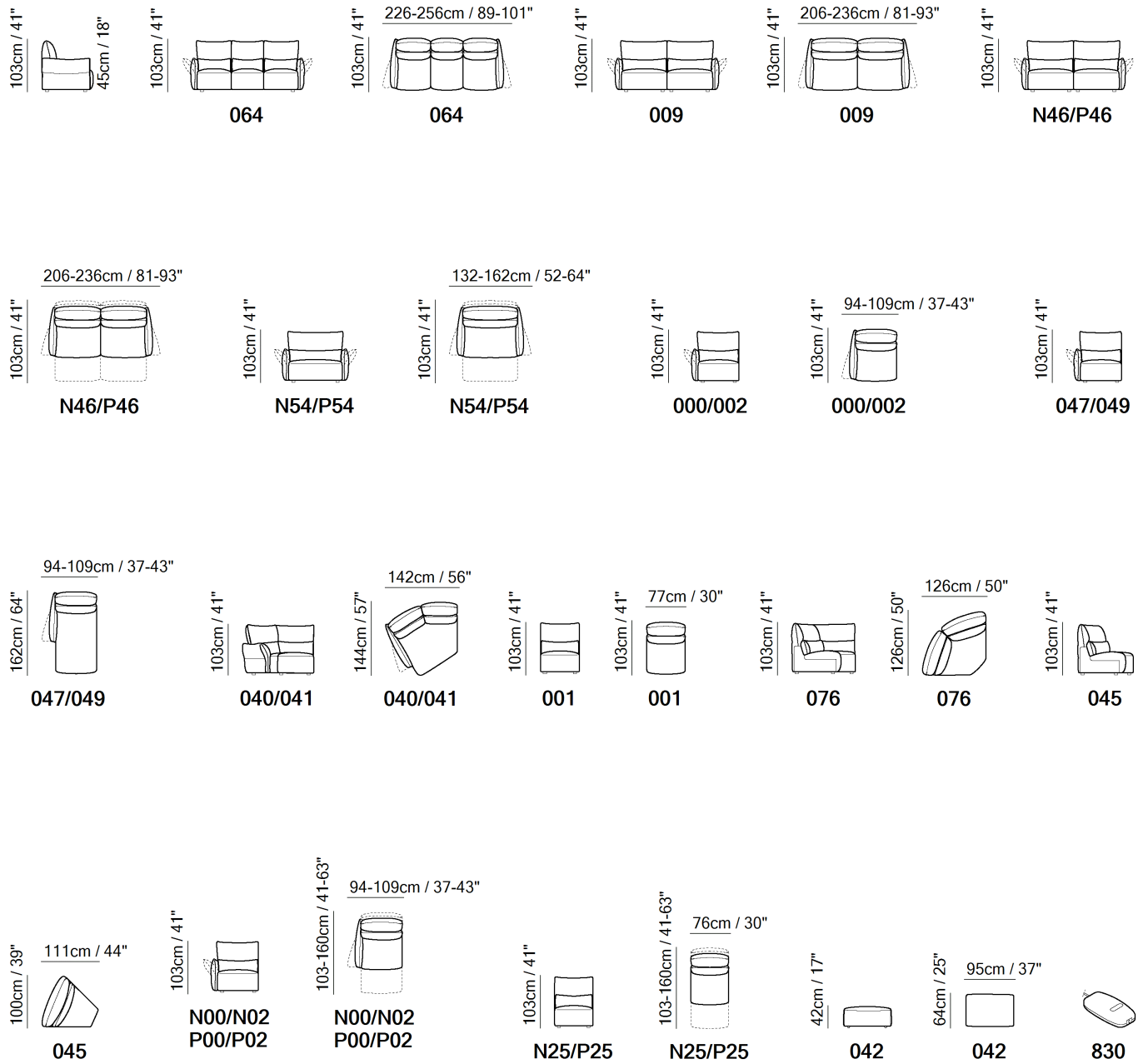

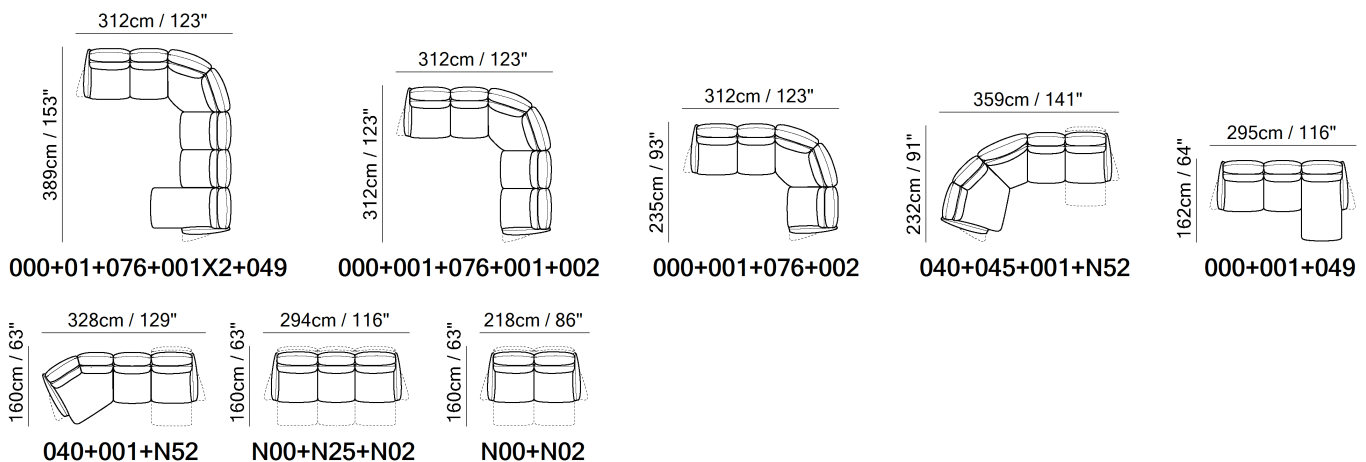

SCHEMATICS



COMPOSITION EXAMPLES



TECHNICAL INFORMATION

	COVERING	Leather <input checked="" type="checkbox"/>	Soft Cover <input checked="" type="checkbox"/>			
	LEGS	Wood <input type="checkbox"/>	Metal <input checked="" type="checkbox"/>	Plastic <input type="checkbox"/>	Castors <input type="checkbox"/>	Upholstered <input type="checkbox"/>
	FILLING	Arms <input type="checkbox"/> Fiber <input checked="" type="checkbox"/> Foam <input type="checkbox"/> Feather/Fiber Mix <input type="checkbox"/> Feather	Seat cushion <input type="checkbox"/> Fiber <input checked="" type="checkbox"/> Foam <input type="checkbox"/> Feather/Fiber Mix <input type="checkbox"/> Feather	Back cushion <input type="checkbox"/> Fiber <input checked="" type="checkbox"/> Foam <input type="checkbox"/> Feather/Fiber Mix <input type="checkbox"/> Feather		
	COMFORT	Standard Comfort <input checked="" type="checkbox"/>	Firm Comfort <input type="checkbox"/>			
	FUNCTION	Bed <input type="checkbox"/>	Electric motion <input checked="" type="checkbox"/>	Motion <input checked="" type="checkbox"/>	Recliner <input checked="" type="checkbox"/>	Sliding <input type="checkbox"/>
	OPTIONS	Nails <input type="checkbox"/>	Removable <input type="checkbox"/>	Contrast Stitching <input type="checkbox"/>		
	WRINKLES & VISUAL APPEARANCE	Low <input type="checkbox"/>	Medium <input type="checkbox"/>	High <input checked="" type="checkbox"/>		

WRINKLES & VISUAL APPEARANCE

Due to a combination of the elasticity of the covering, the nature of the interior construction and the design for comfortability of the product, the model may exhibit differing levels of wrinkles.



The models need to be dressed on a regular basis to maintain their appearance and the wrinkles should not be considered as a manufacturing defect, but a natural characteristic of the product.

NOTES

- Designed by Natuzzi Design Center.
- Date of launch: 2023.
- A never ending relax.
A modular system that brings together the brand's key features, such as comfort and functionality, updating them in a contemporary and versatile design.
The wide abacus allows the creation of countless configurations suitable for all needs and spaces.
- In leather the model is available starting from cat. 15.
- Thin-profile armrest with pillow shape also on backrest. To reinforce this concept, the band running around the entire perimeter of the sofa can be tone-on-tone or contrasting.
- Model can be ordered as follows:
 1. In leather, single covering;
 2. In leather, with leather piping chosen between Lemans (cat. 15) and Stromboli (cat. 30);
 3. In fabric, single covering;
 4. In fabric, with leather piping chosen between Lemans (cat. 15) and Stromboli (cat. 30).
- Seat and back cushion composed of polyurethane foam in different densities: firmer on the seat (40) and softer on the back (35).

NOTES

- Relax function with triple motion mechanism.
Triple motion mechanism activates footrest, headrest and lumbar support.
- Wellbe has a "home" button that resets from the relax position to the original position all in one movement. The "home" button is the first of the three switches and is activated by continuous pressure.
- Vers. P00-P02-P25-P46-P54: possibility to activate the recliner function also via downloadable APP.
- The armless chair has buttons on the right side of the seat.
- Flexible armrest in the front with storage pocket.
- Equipped with satin label that is intended to indicate the position of the control panel.
- Lovechair has a recliner.
- The corner module has been designed with a wedge to improve its comfort and provide better functionality without compromising the design.
- Seats come in 3 different width:
 - N46-009 wide seat;
 - N00/N02-000/002-001-N25 medium seat;
 - 064 small seat.
- Internal plywood frame, elastic straps under the seat cushions and on the backrest.
- Hooks on each seat.
- No upholstered side.
- The hidden metal feet with anti-scratch and non-slip rubbers offer a practical solution for protecting floors.
- Feet requires assembling. Feet will be in a bag inside the package.
- Feet height 4 cm.