



■ Vers. 272+291+011+274



■ Vers. 272+291+011+274



■ Vers. 272+274



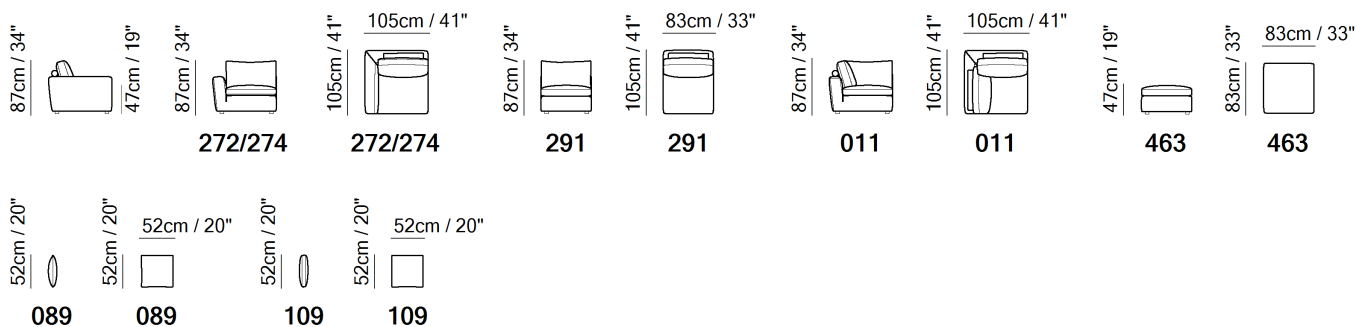

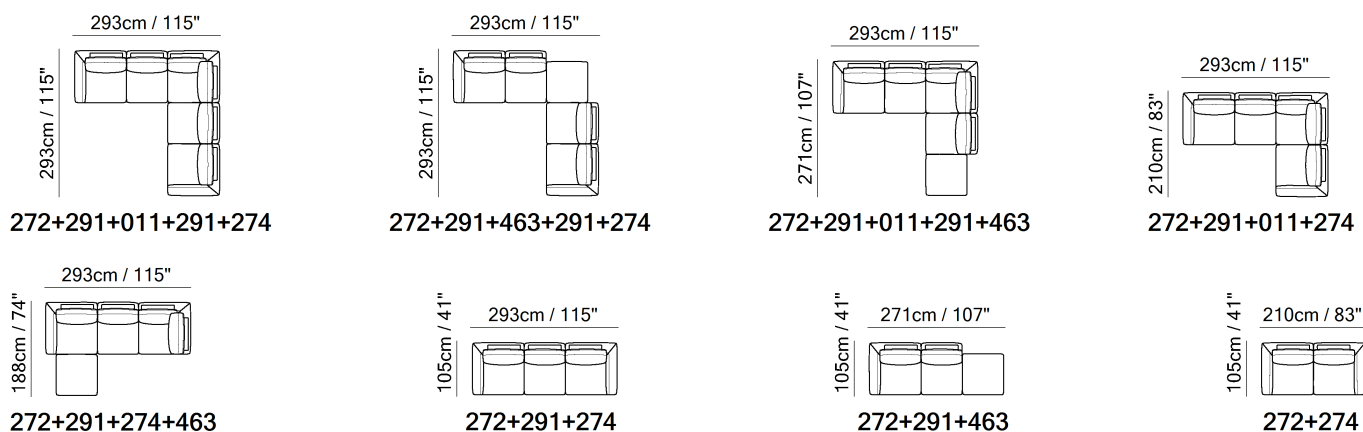

**SCHEMATICS**



**COMPOSITION EXAMPLES**



TECHNICAL INFORMATION

	<b>COVERING</b>	Leather <input checked="" type="checkbox"/>	Soft Cover <input checked="" type="checkbox"/>			
	<b>LEGS</b>	Wood <input type="checkbox"/>	Metal <input checked="" type="checkbox"/>	Plastic <input type="checkbox"/>	Castors <input type="checkbox"/>	Upholstered <input type="checkbox"/>
	<b>FILLING</b>	Arms <input type="checkbox"/> Fiber <input type="checkbox"/> Foam <input type="checkbox"/> Feather/Fiber Mix <input type="checkbox"/> Feather	Seat cushion <input type="checkbox"/> Fiber <input type="checkbox"/> Foam <input type="checkbox"/> Feather/Fiber Mix <input type="checkbox"/> Feather	Back cushion <input type="checkbox"/> Fiber <input type="checkbox"/> Foam <input type="checkbox"/> Feather/Fiber Mix <input type="checkbox"/> Feather		
	<b>COMFORT</b>	Standard Comfort <input checked="" type="checkbox"/>	Firm Comfort <input type="checkbox"/>			
	<b>FUNCTION</b>	Bed <input type="checkbox"/>	Electric motion <input type="checkbox"/>	Motion <input type="checkbox"/>	Recliner <input type="checkbox"/>	Sliding <input type="checkbox"/>
	<b>OPTIONS</b>	Nails <input type="checkbox"/>	Removable <input type="checkbox"/>	Contrast Stitching <input type="checkbox"/>		
	<b>WRINKLES &amp; VISUAL APPEARANCE</b>	Low <input type="checkbox"/>	Medium <input checked="" type="checkbox"/>	High <input type="checkbox"/>		

WRINKLES & VISUAL APPEARANCE

Due to a combination of the elasticity of the covering, the nature of the interior construction and the design for comfortability of the product, the model may exhibit differing levels of wrinkles.



The models need to be dressed on a regular basis to maintain their appearance and the wrinkles should not be considered as a manufacturing defect, but a natural characteristic of the product.

NOTES

- In leather, to avoid cuts on the seat and back cushions, the model is available starting from cat. 15
- Seat cushions in high density polyurethane (35).
- Upholstered sofa sides with hidden, removable hooks
- Under the seat there are elastic straps which guarantee the same comfort for every seat and more lasting support.
- Removable back and seat cushions.
- The back cushions have a roller that rests on the backrest in order to ensure greater support for the back to be positioned according to anyone's height to find the desired ergonomics.
- Versions 089 and 109: Loose cushions in two sizes can be ordered in different coverings and colors than the seats. They can be used as a lumbar support or as a support on the armrest.
- Version 463 can be used as an ottoman or corner without backrest as it is equipped with hooks.
- The back cushions have a layer of Climalight, a particular microfibre made of 100% recycled polyester from PET which makes them extremely soft, it also regains its original shape when the pressure from the body is less.

## NOTES

---

- The hidden metal feet with anti-scratch and non-slip rubbers offer a practical solution for protecting floors.