

# BONALDO

## Globalove



Вдохновленное идеей чистоты и сведения форм к главному, идеально напоминающему формы "Матери-Земли", кресло Globalove, разработанное Karim Rashid, выделяется, в частности, удобным, обволакивающим сиденьем с оригинальным силуэтом. Опираясь на пол, сиденье приобретает конфигурацию круглой полосы, в

которую вставляется спинка и помещается подушка. Дизайнерский стиль Karim Rashid проявляется и в комбинациях обивки, которая может быть контрастной и ярко выраженной, но при этом гармонично сочетаться с другими элементами обстановки.



# Технические данные

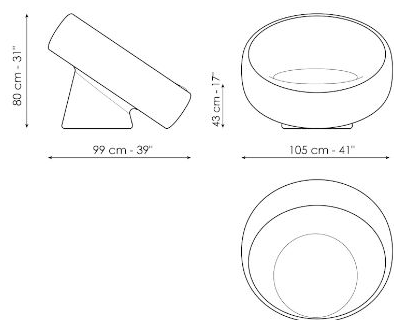

**Globalove**

Ширина: 99cm

Глубина: 105cm

Высота: 80cm

# Finishes

## ОБИВКА

Ткань - 900



Ткань - Azimut  
9B02

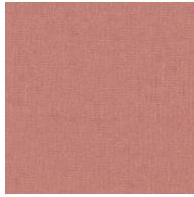

Ткань - Azimut  
9B08

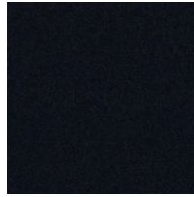

Ткань - Azimut  
9B17



Ткань - Azimut  
9B22



Ткань - Azimut  
9B26

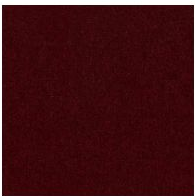

Ткань - Azimut  
9B36



Ткань - Azimut  
9B39



Ткань - Azimut  
9B42



Ткань - Azimut  
9B44

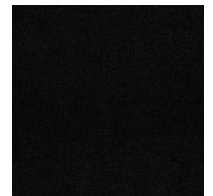

Ткань - Azimut  
9B48



Fabric - Newco  
9B65

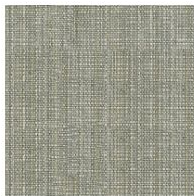

Fabric - Newco  
9B66



Fabric - Newco  
9B67



Fabric - Newco  
9B68



Fabric - Newco  
9B69



Fabric - Newco  
9B70



Fabric - Newco  
9B71



Fabric - Newco  
9B72

Ткань - Must



Ткань - Boemian  
MC40

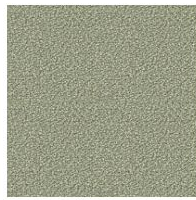

Ткань - Boemian  
MC43

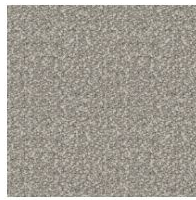

Ткань - Boemian  
MC46



Ткань - Boemian  
MC47



Ткань - Boemian  
MC49

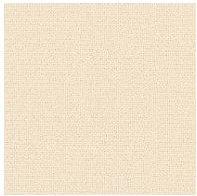

Ткань - Rico  
MA02

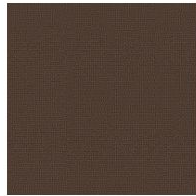

Ткань - Rico  
MA04

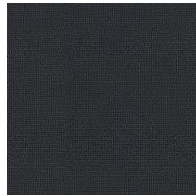

Ткань - Rico  
MA07



Ткань - Rico  
MA09



Ткань - Rico  
MA11



Ткань - Rico  
MA20

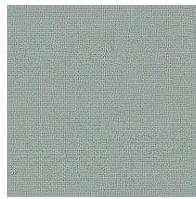

Ткань - Rico  
MA22

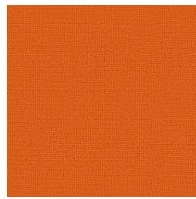

Ткань - Rico  
MA39



Ткань - St. Moritz  
MC60



Ткань - St. Moritz  
MC61



Ткань - St. Moritz  
MC62



Ткань - St. Moritz  
MC67



Ткань - St. Moritz  
MC69

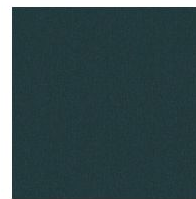

Ткань - St. Moritz  
MC76



Ткань - St. Moritz  
MC81

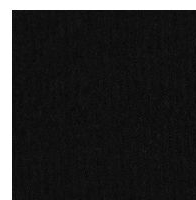
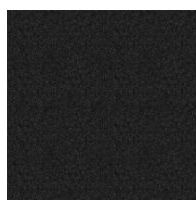

Ткань - St. Moritz  
MC83

Ткань - St. Moritz  
MC85



Ткань - Flora  
MD30



Ткань - Flora  
MD31



Ткань - Flora  
MD32



Ткань - Flora  
MD34



Ткань - Flora  
MD35



Ткань - Flora  
MD37



Ткань - Flora  
MD39



Ткань - Nacchero  
MD41

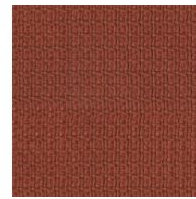

Ткань - Nacchero  
MD44



Ткань - Nacchero  
MD45



Ткань - Nacchero  
MD47



Ткань - Nacchero  
MD48

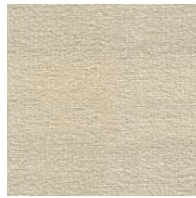

Fabric - Lucky  
MD58



Fabric - Lucky  
MD59



Fabric - Lucky  
MD60



Fabric - Lucky  
MD61

Ткань - Special



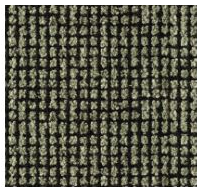

Ткань - Brionne  
SP19



Ткань - Brionne  
SP20



Ткань - Brionne  
SP21



Ткань - Brionne  
SP22



Ткань - Brionne  
SP23

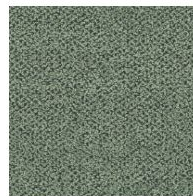

Ткань - Rella  
SP01

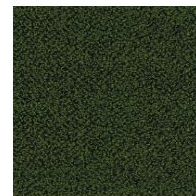

Ткань - Rella  
SP04



Ткань - Rella  
SP05

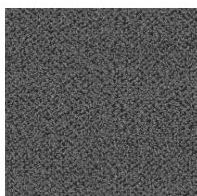

Ткань - Rella  
SP06



Ткань - Rella  
SP07



Ткань - Diamon  
Frisé  
SP31



Ткань - Diamon  
Frisé  
SP33

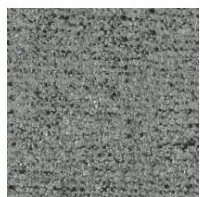

Ткань - Diamon  
Frisé  
SP36



Ткань - Diamon  
Frisé  
SP34



Ткань - Diamon  
Frisé  
SP38



Ткань - Baia  
SP45



Ткань - Baia  
SP48



Ткань - Baia  
SP50



Ткань - Baia  
SP51



Ткань - Baia  
SP52



Fabric - Jurga  
SP53



Fabric - Jurga  
SP54



**Fabric - Jurga**  
SP55

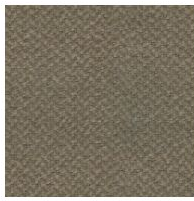

**Fabric - Jurga**  
SP56

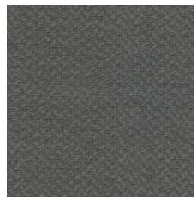

**Fabric - Jurga**  
SP57

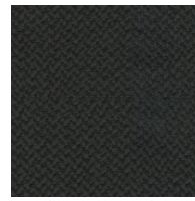

**Fabric - Jurga**  
SP58

Ткань - 800



Ткань - Pastello  
8D69



Fabric - Pastello  
8D68



Fabric - Pastello  
8D67



Fabric - Pastello  
8D66

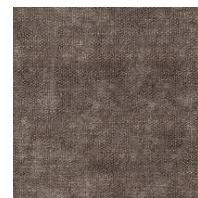

Fabric - Pastello  
8D65



Fabric - Pastello  
8D64



Fabric - Pastello  
8D63



Fabric - Pastello  
8D62



Fabric - Pastello  
8D61

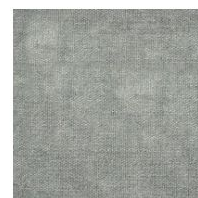

Fabric - Pastello  
8D60



Fabric - Pastello  
8D59



Fabric - Pastello  
8D58



Fabric - Pastello  
8D57



Fabric - Pastello  
8D56



Fabric - Pastello  
8D55



Fabric - Pastello  
8D54

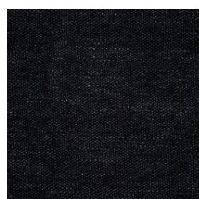

Fabric - Pastello  
8D53



Fabric - Pastello  
8D52



## Ткань - Class



**Fabric - Hyle**  
EB55



**Fabric - Hyle**  
EB56



**Fabric - Hyle**  
EB57



**Fabric - Hyle**  
EB58



**Fabric - Hyle**  
EB59



**Fabric - Hyle**  
EB60



**Fabric - Hyle**  
EB61



**Fabric - Hyle**  
EB62

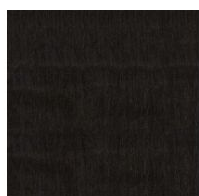

**Fabric - Hyle**  
EB63

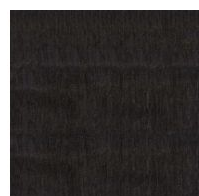

**Fabric - Hyle**  
EB64

---

Materials, fabrics, leathers, colors and finishes are approximate and may slightly differ from actual ones. You can find the complete collection of Bonaldo fabrics and leathers on the website

