

BONALDO

Newton, Newton low



The Newton office armchair is immediately impressive thanks to its imposing seat, which offers all-enveloping comfort, resulting from the high backrest and the wide and comfortable shell. In addition to offering maximum comfort, essential for prolonged use of the armchair in work environments, the high backrest makes it elegant and perfect for the business world, where it can be placed within an executive or presidential context. Newton is upholstered in

either a single-material version in leather or fabric, or in a double-covering version in which the seat is in fabric and the front cushions are available in leather. The swivel base has five supports on wheels. The Newton low office armchair is part of the Newton family and as such it can be combined to complement an executive office as a guest seat, while also being perfect as an independent element in modern and elegant office and living spaces.



Технические данные

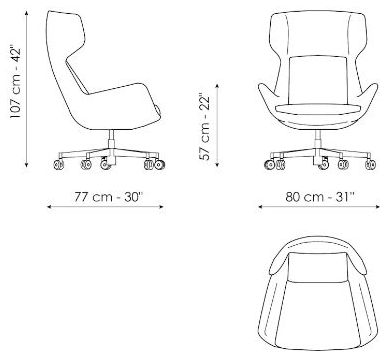

Newton

Ширина: 77cm
Глубина: 80cm
Высота: 107cm

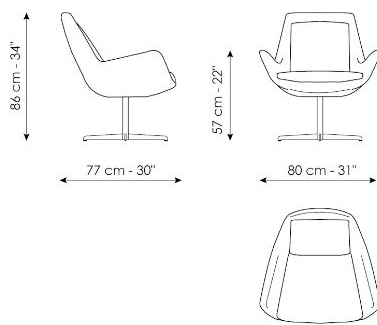

Newton low

Ширина: 77cm
Глубина: 80cm
Высота: 86cm

Finishes

ОБИВКА

Ткань - 900

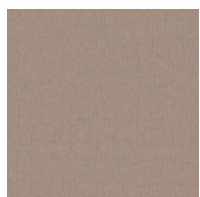

Ткань - Azimut
9B02



Ткань - Azimut
9B08

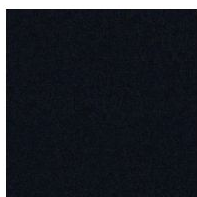

Ткань - Azimut
9B17



Ткань - Azimut
9B22



Ткань - Azimut
9B26



Ткань - Azimut
9B36



Ткань - Azimut
9B39



Ткань - Azimut
9B42

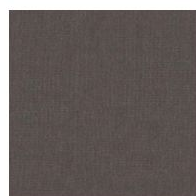

Ткань - Azimut
9B44

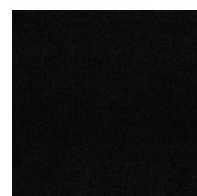

Ткань - Azimut
9B48



Fabric - Newco
9B65



Fabric - Newco
9B66



Fabric - Newco
9B67



Fabric - Newco
9B68



Fabric - Newco
9B69



Fabric - Newco
9B70



Fabric - Newco
9B71



Fabric - Newco
9B72

Ткань - Must



Ткань - Boemian
MC40

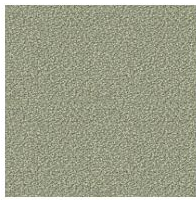

Ткань - Boemian
MC43

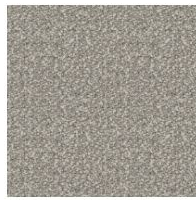

Ткань - Boemian
MC46



Ткань - Boemian
MC47



Ткань - Boemian
MC49



Ткань - Rico
MA02

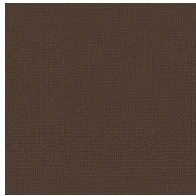

Ткань - Rico
MA04

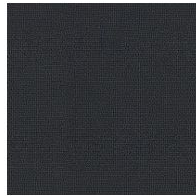

Ткань - Rico
MA07



Ткань - Rico
MA09



Ткань - Rico
MA11



Ткань - Rico
MA20

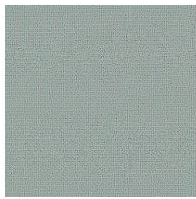

Ткань - Rico
MA22

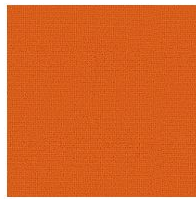

Ткань - Rico
MA39



Ткань - St. Moritz
MC60



Ткань - St. Moritz
MC61



Ткань - St. Moritz
MC62



Ткань - St. Moritz
MC67



Ткань - St. Moritz
MC69

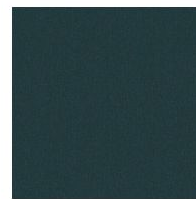

Ткань - St. Moritz
MC76



Ткань - St. Moritz
MC81

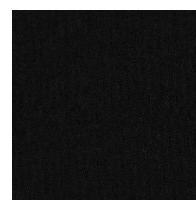
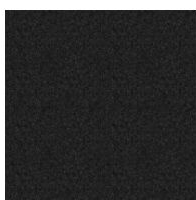

Ткань - St. Moritz
MC83

Ткань - St. Moritz
MC85



Ткань - Flora
MD30



Ткань - Flora
MD31



Ткань - Flora
MD32



Ткань - Flora
MD34



Ткань - Flora
MD35



Ткань - Flora
MD37



Ткань - Flora
MD39



Ткань - Nacchero
MD41

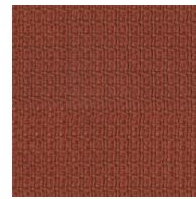

Ткань - Nacchero
MD44



Ткань - Nacchero
MD45



Ткань - Nacchero
MD47



Ткань - Nacchero
MD48

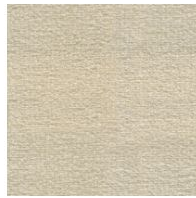

Fabric - Lucky
MD58



Fabric - Lucky
MD59



Fabric - Lucky
MD60



Fabric - Lucky
MD61

Ткань - Special



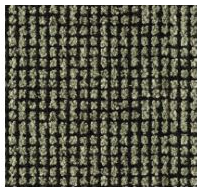

Ткань - Brionne
SP19



Ткань - Brionne
SP20



Ткань - Brionne
SP21



Ткань - Brionne
SP22



Ткань - Brionne
SP23



Ткань - Rella
SP01

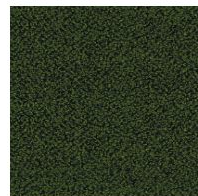

Ткань - Rella
SP04



Ткань - Rella
SP05

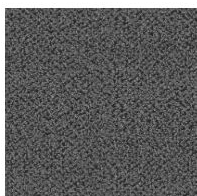

Ткань - Rella
SP06



Ткань - Rella
SP07



Ткань - Diamon
Frisé
SP31

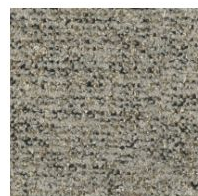

Ткань - Diamon
Frisé
SP33

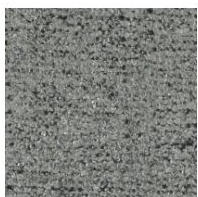

Ткань - Diamon
Frisé
SP36



Ткань - Diamon
Frisé
SP34



Ткань - Diamon
Frisé
SP38



Ткань - Baia
SP45



Ткань - Baia
SP48



Ткань - Baia
SP50



Ткань - Baia
SP51



Ткань - Baia
SP52



Fabric - Jurga
SP53



Fabric - Jurga
SP54



Fabric - Jurga
SP55

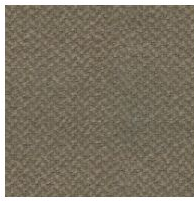

Fabric - Jurga
SP56

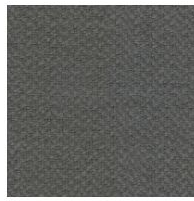

Fabric - Jurga
SP57

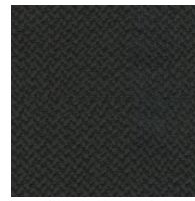

Fabric - Jurga
SP58

Ткань - 800



Ткань - Pastello
8D69



Fabric - Pastello
8D68



Fabric - Pastello
8D67



Fabric - Pastello
8D66

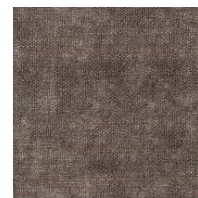

Fabric - Pastello
8D65



Fabric - Pastello
8D64

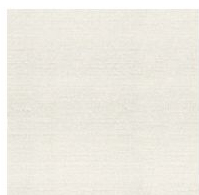

Fabric - Pastello
8D63



Fabric - Pastello
8D62



Fabric - Pastello
8D61

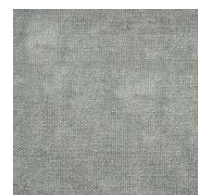

Fabric - Pastello
8D60



Fabric - Pastello
8D59



Fabric - Pastello
8D58



Fabric - Pastello
8D57



Fabric - Pastello
8D56



Fabric - Pastello
8D55



Fabric - Pastello
8D54



Fabric - Pastello
8D53



Fabric - Pastello
8D52

Ткань - Class



Fabric - Hyle
EB55



Fabric - Hyle
EB56



Fabric - Hyle
EB57



Fabric - Hyle
EB58



Fabric - Hyle
EB59



Fabric - Hyle
EB60



Fabric - Hyle
EB61



Fabric - Hyle
EB62



Fabric - Hyle
EB63



Fabric - Hyle
EB64

ВРАЩАЮЩИМСЯ ОСНОВАНИЕМ

Металл категория Plus



Крашенный металл
Матовый
бронзовый

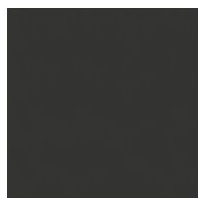

Крашенный металл
Матовый свинец

Materials, fabrics, leathers, colors and finishes are approximate and may slightly differ from actual ones. You can find the complete collection of Bonaldo fabrics and leathers on the website

