

Molteni & C

HI-BRIDGE — FERRUCCIO LAVIANI 2005

1—
5



Large-size seats for handy and comfortable use. A very versatile system made up of plain, linear shapes. Ferruccio Laviani designs a line of seats for today's homes with the absolute elegance of classic style. The cushions set casually on top overlap the continuous profile of the backrest to create different seat configurations. The seats project from the overall shape of the load bearing structures, protecting the base and emphasizing the comfort of the large seat surfaces. Large end elements to suit a sofa understood as a welcoming shelter to lie down in.

FEATURES

A series of upholstered sofas, individual or modular, characterised by a L shaped double structure when combining 2 sofas together, as the structure of one element is extended in order to be inserted under the sofa next to it.

DATASHEET

VII.2016

molteni.it

Dimensions in millimeters and inches. The right to discontinue and make changes is reserved. This information is based on the latest product information available at the time of printing.

FINISHES

COVERS

fabric - leather, completely removable.

Available in fire-resistant version (TB117 and BS5852).

FEET FINISH

shiny steel

Molteni & C

TECHNICAL INFORMATION

STRUCTURE INTERIOR

Frame made of solid fir (Picea abies) and chipboard, with elastic straps.

STRUCTURE PADDING

High capacity variable density foam polyurethane. Light velvet cover.

SEAT CUSHION (EXCEPT OF POUF)

Insert in shaped polyurethane and sterilised feathers. 100% cotton cover.

BACK CUSHIONS

Shaped polyurethane flakes and sterilized feathers. 100% cotton cover.

FEET (EXCEPT OF POUF)

Shiny metal with non-slip plastic tips.

REMOVABLE OUTER COVERS

(See attached card, specific for each cover).

2—
5

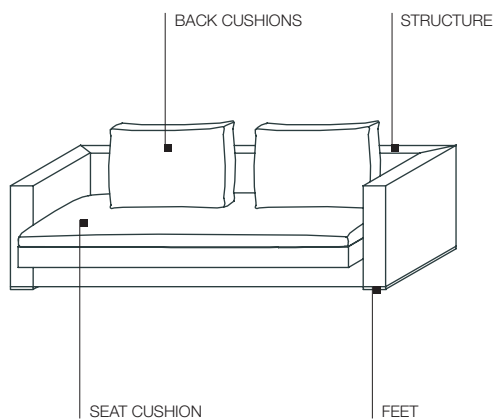

DATASHEET

VII.2016

molteni.it

Dimensions in millimeters and inches. The right to discontinue and make changes is reserved. This information is based on the latest product information available at the time of printing.

COMPOSITIONS

Measurement for compositions

Compositions are always created using an end element.
When considering angle depth, use armrest depth 800 mm (31 1/2") and not total depth of the element 970 mm (38 1/4")

Molteni & C

3—
5

Examples with square corner

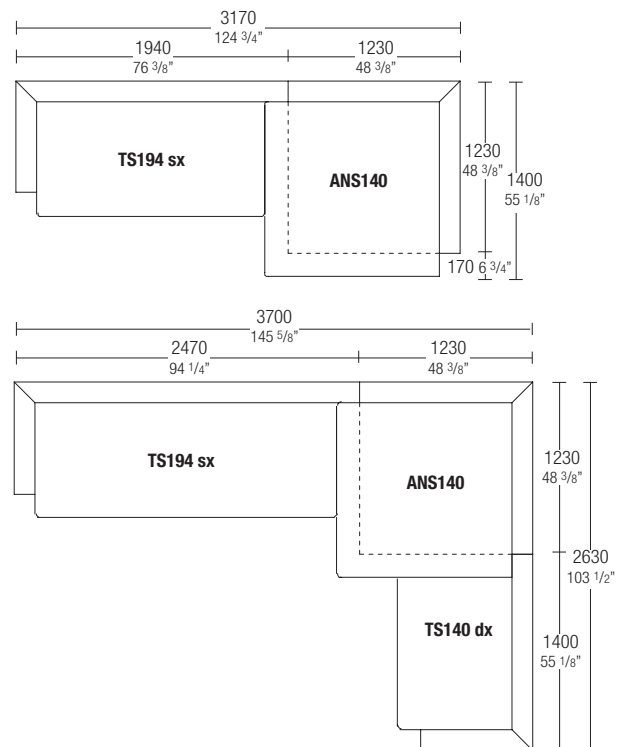
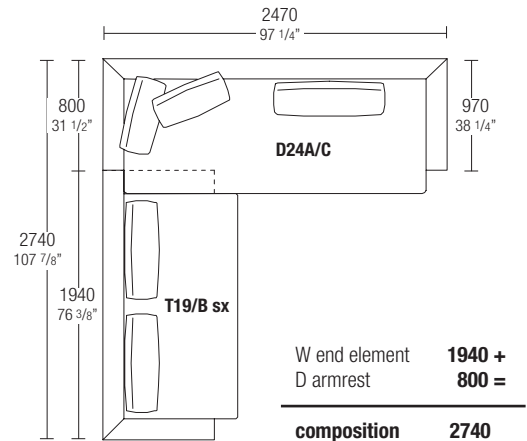

Measurement for a composition with a modular pouf

If a modular pouf is added as end element, it will lengthen the composition of 430 mm (16 7/8").

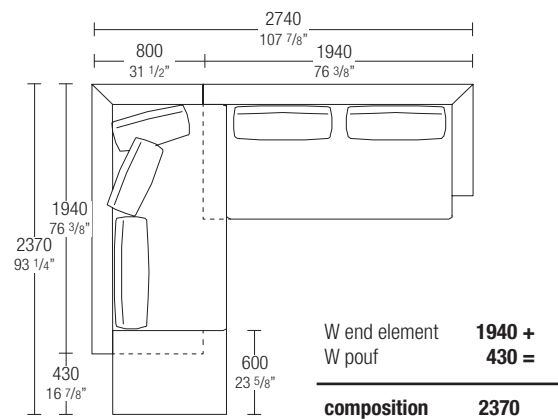

DATASHEET

VII.2016

molteni.it

Dimensions in millimeters and inches. The right to discontinue and make changes is reserved. This information is based on the latest product information available at the time of printing.

DIMENSIONS

Molteni & C

4—
5

sofa structure

W 1940 D 970/800 H 680
W 76 3/8" D 38 1/4" - 31 1/2" H 26 3/4"

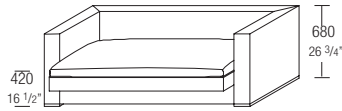

DS194

back cushion

W 800 H 500
W 31 1/2" H 19 3/4"



CS80

W 700 H 500
W 27 1/2" H 19 3/4"



CS70

W 550 H 500
W 21 5/8" H 19 3/4"



CS55

**sofa structure
single cushion seating**

W 2470 D 970/800 H 680
W 97 1/4" D 38 1/4" - 31 1/2" H 26 3/4"

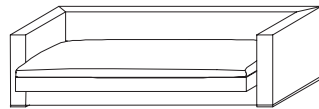

DS247A

back cushion

W 800 H 500
W 31 1/2" H 19 3/4"

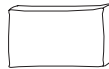

CS80

W 700 H 500
W 27 1/2" H 19 3/4"



CS70

W 550 H 500
W 21 5/8" H 19 3/4"



CS55

**sofa structure
multi cushion seating**

W 2470 D 970/800 H 680
W 97 1/4" D 38 1/4" - 31 1/2" H 26 3/4"

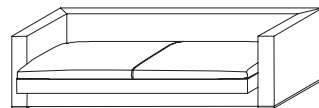

DS247B

back cushion

W 800 H 500
W 31 1/2" H 19 3/4"



CS80

W 700 H 500
W 27 1/2" H 19 3/4"



CS70

W 550 H 500
W 21 5/8" H 19 3/4"



CS55

sofa structure

W 3140 D 970/800 H 680
W 123 5/8" D 38 1/4" - 31 1/2" H 26 3/4"
composed of 2 elements W 1570 W 61 7/8"



DS314

back cushion

W 800 H 500
W 31 1/2" H 19 3/4"



CS80

W 700 H 500
W 27 1/2" H 19 3/4"



CS70

W 550 H 500
W 21 5/8" H 19 3/4"



CS55

chaise longue structure

W 970/800 D 1770 H 680
W 38 1/4" - 31 1/2" D 69 3/4" H 26 3/4"

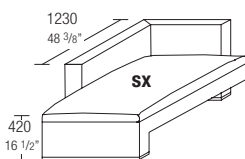

CLS177 dx - sx

back cushion

W 800 H 500
W 31 1/2" H 19 3/4"



CS80

W 700 H 500
W 27 1/2" H 19 3/4"



CS70

W 550 H 500
W 21 5/8" H 19 3/4"



CS55

DATASHEET

DIMENSIONS

Molteni & C

5—
5

chaise longue structure
W 970/800 D 2300 H 680
W 38 1/4" - 31 1/2" D 90 1/2" H 26 3/4"

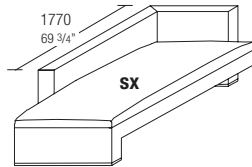

CLS230 dx - sx

back cushion
W 800 H 500
W 31 1/2" H 19 3/4"



CS80

W 700 H 500
W 27 1/2" H 19 3/4"



CS70

W 550 H 500
W 21 5/8" H 19 3/4"



CS55

end element structure
W 1400/1230 D 970/800 H 680
W 55 1/8" - 48 3/8" D 38 1/4" - 31 1/2" H 26 3/4"

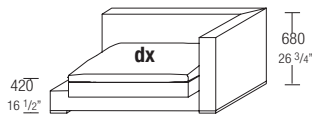

TS140 dx - sx

back cushion
W 800 H 500
W 31 1/2" H 19 3/4"



CS80

W 700 H 500
W 27 1/2" H 19 3/4"



CS70

W 550 H 500
W 21 5/8" H 19 3/4"



CS55

end element structure
W 1940/1770 D 970/800 H 680
W 76 3/8" - 69 3/4" D 38 1/4" - 31 1/2" H 26 3/4"

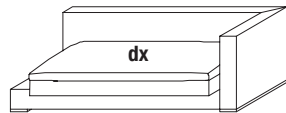

TS194 dx - sx

back cushion
W 800 H 500
W 31 1/2" H 19 3/4"



CS80

W 700 H 500
W 27 1/2" H 19 3/4"



CS70

W 550 H 500
W 21 5/8" H 19 3/4"



CS55

end element structure
W 2470/2300 D 970/800 H 680
W 97 1/4" - 90 1/2" D 38 1/4" - 31 1/2" H 26 3/4"

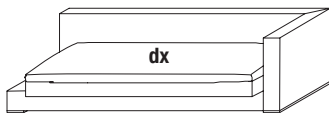

TS247 dx - sx

back cushion
W 800 H 500
W 31 1/2" H 19 3/4"



CS80

W 700 H 500
W 27 1/2" H 19 3/4"



CS70

W 550 H 500
W 21 5/8" H 19 3/4"



CS55

corner element structure
W 1400/1230 D 1400/1230 H 680
W 55 1/8" - 48 3/8" D 55 1/8" - 48 3/8" H 26 3/4"

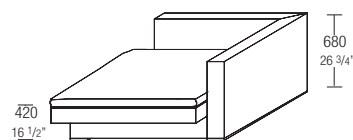

ANS140

pouf
W 970 D 970 H 400
W 38 1/4" D 38 1/4"
H 15 3/4"

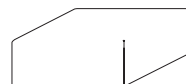

PF97

modular pouf
W 600 D 800 H 400
W 23 5/8" D 31 1/2"
H 15 3/4"



PF60 dx - sx

extra cushion
W 500 H 400
W 19 3/4"
H 15 3/4"



CU/50/40

pair of extra cushions
W 500 H 500
W 19 3/4"
H 19 3/4"



CCQ/50

DATASHEET

VII.2016

molteni.it

Dimensions in millimeters and inches. The right to discontinue and make changes is reserved. This information is based on the latest product information available at the time of printing.