

# Molteni & C

## TURNER — HANNES WETTSTEIN 2008

1—  
5



Formal moment or relaxing space? Turner, the seating system designed by Hannes Wettstein, combines comfort with refinement. Settees in various sizes, corner pieces, chaises-longue and pouf can be combined together to create different furnishing solutions. Turner responds to varying needs in terms of comfort and posture, thanks to an easy mechanism which adjusts the depth of the seating.

**DATASHEET**

REGISTERED  
DESIGN

VII.2016

**molteni.it**

Dimensions in millimeters and inches. The right to discontinue and make changes is reserved. This information is based on the latest product information available at the time of printing.

## FINISHES

### COVERS

fabric - leather, completely removable.  
The seating cushions are not reversible.

### FEET FINISH

shiny aluminium

Available in fire-resistant version (TB117 and BS5852).

## TECHNICAL INFORMATION

### STRUCTURE INTERIOR

Frame made of solid fir (*Picea abies*) and chipboard, with elastic straps.

### STRUCTURE PADDING

High capacity variable density foam polyurethane. Light velvet cover.

### SEAT CUSHIONS

Insert in shaped polyurethane and sterilised feathers. 100% cotton cover.

### BACK CUSHIONS

Polyurethane flakes and sterilised down feathers in compartments. 100% cotton cover.

### FRAME

Painted metal with feet in non-slip plastic.

### FEET

Extruded aluminium, anodised or painted.

### REMOVABLE OUTER COVERS

(See attached card, specific for each cover).

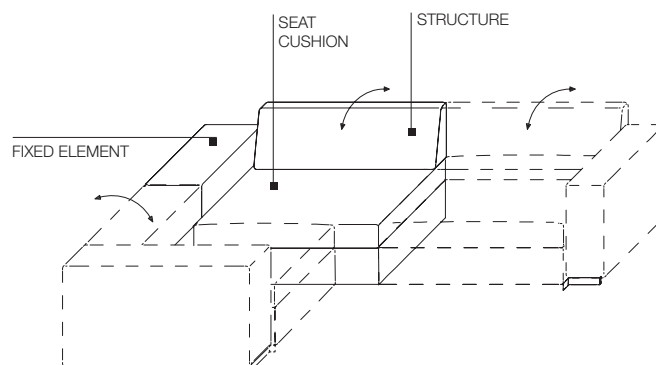
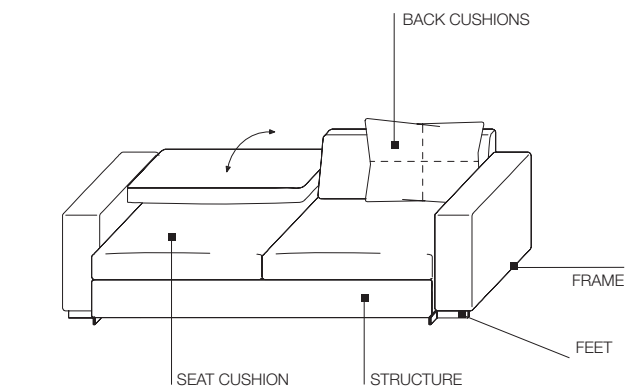

## DATASHEET

REGISTERED  
DESIGN

VII.2016

## DIMENSIONS

### End units, central units, chaise longues and islands

Elements **cannot be used individually.**

All elements have back with mechanism.

**The compositions are always closed at the side with an arm.**

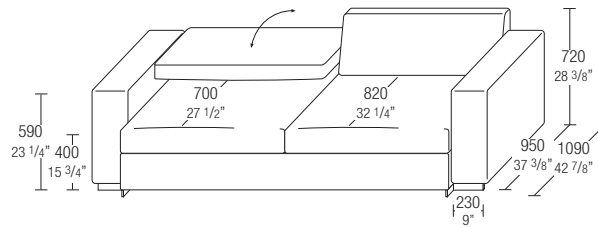

## Molteni & C

3—  
5

### Corner

The corner element **cannot be used alone** but must be placed by a central or terminal element, on the opposite side to the arm. The corner element comes with mechanism only on the long side.

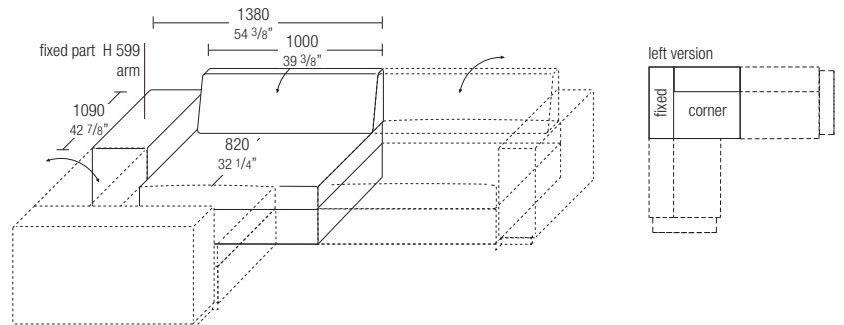

### Island element

The island element cannot be used alone, but must be used along with a central, end or corner element on the side opposite the armrest.

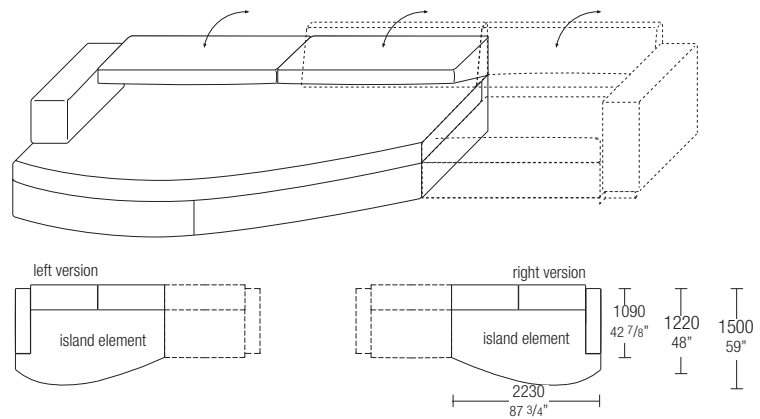

### Sofa

The settee is a finite element which stands alone

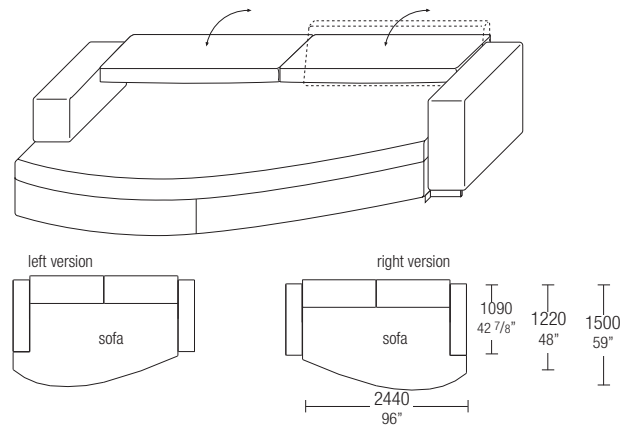

## DATASHEET

REGISTERED  
DESIGN

VII.2016

## DIMENSIONS

### Notes

- Each single element (terminal, central, corner, chaise longue, island or sofa) must be completed, in the interests of ergonomic quality, with one or more back cushions to choose from: TCS60 - TCS70 - TCS80.
- The seating cushion cover for the island IS223 and sofa DI244, in contrast with all other elements, must have a front strip; when ordering one of these items, all the covers for the seating cushions in the Order will be made with a front strip.

Molteni & C

4—  
5

### end element

W 1080 D 1090 H 590/720  
W 42 1/2" D 42 7/8" H 23 1/4" - 28 3/8"

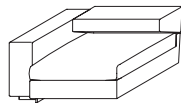

T108 dx - sx

W 1230 D 1090 H 590/720  
W 48 3/8" D 42 7/8" H 23 1/4" - 28 3/8"

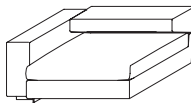

T123 dx - sx

W 1430 D 1090 H 590/720  
W 56 1/4" D 42 7/8" H 23 1/4" - 28 3/8"

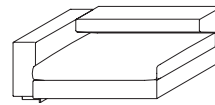

T143 dx - sx

### central

W 850 D 1090 H 590/720  
W 33 1/2" D 42 7/8" H 23 1/4" - 28 3/8"

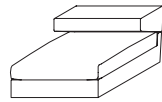

CE85

W 1000 D 1090 H 590/720  
W 39 3/8" D 42 7/8" H 23 1/4" - 28 3/8"

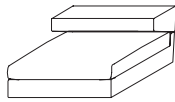

CE100

W 1200 D 1090 H 590/720  
W 47 1/4" D 42 7/8" H 23 1/4" - 28 3/8"

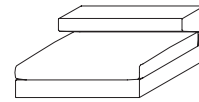

CE120

### chaise longue

W 1080 D 2100 H 590/720  
W 42 1/2" D 82 3/4" H 23 1/4" - 28 3/8"

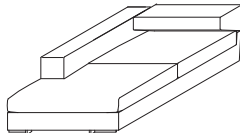

CL108 dx - sx

W 1230 D 1600 H 590/720  
W 48 3/8" D 63" H 23 1/4" - 28 3/8"

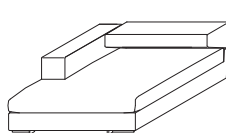

CL123 dx - sx

### island

W 1080 D 2100 H 590/720  
W 42 1/2" D 82 3/4" H 23 1/4" - 28 3/8"

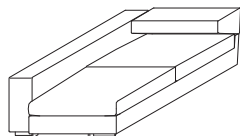

IS108 dx - sx

W 1230 D 1600 H 590/720  
W 48 3/8" D 63" H 23 1/4" - 28 3/8"

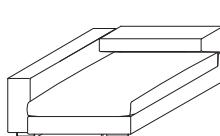

IS123 dx - sx

W 1430 D 1600 H 590/720  
W 56 1/4" D 63" H 23 1/4" - 28 3/8"

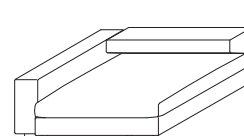

IS143 dx - sx

### island

W 2230 D 1500 H 590/720  
W 87 3/4" D 59" H 23 1/4" - 28 3/8"

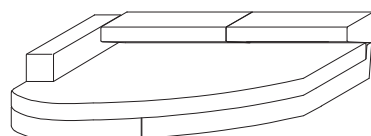

IS223 dx - sx

### sofa

W 2440 D 1500 H 590/720  
W 96" D 59" H 23 1/4" - 28 3/8"

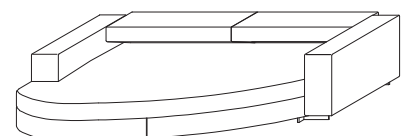

DI244 dx - sx

DATASHEET

REGISTERED  
DESIGN

VII.2016

molteni.it

Dimensions in millimeters and inches. The right to discontinue and make changes is reserved. This information is based on the latest product information available at the time of printing.

## DIMENSIONS

### corner

W 1380 D 1090 H 590/720

W 54 3/8" D 42 7/8" H 23 1/4" - 28 3/8"

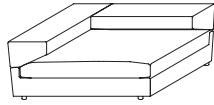

**AN138 dx - sx**

**Molteni & C**

### pouf

W 1000 D 850 H 400

W 39 3/8" D 33 1/2" H 15 3/4"

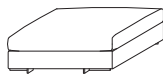

**PF100**

### pouf

W 1080 D 1080 H 400

W 42 1/2" D 42 1/2" H 15 3/4"



**PF108**

### pouf

W 1200 D 1000 H 400

W 47 1/4" D 39 3/8" H 15 3/4"

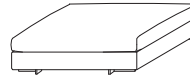

**PF120**

### pair of extra cushions

W 500 H 500

W 19 3/4" D 19 3/4"

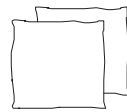

**CCQ/50**

### back cushion

W 600 H 600

W 23 5/8" D 23 5/8"

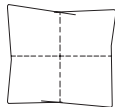

**TCS60**

W 700 H 600

W 27 1/2" D 23 5/8"

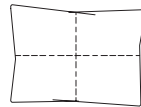

**TCS70**

W 800 H 600

W 31 1/2" D 23 5/8"

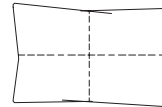

**TCS80**

## SAMPLE COMPOSITIONS

### composition 4

W 3010 D 1090

W 118 1/2" D 42 7/8"

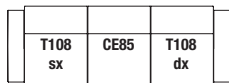

**TC04**

### composition 10

W 3010 D 1090/2100

W 118 1/2" D 42 7/8" - 82 3/4"

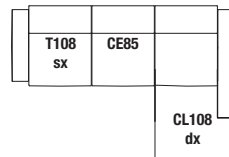

**TC10**

### composition 23

W 3610 D 3320

W 142 1/8" D 130 3/4"

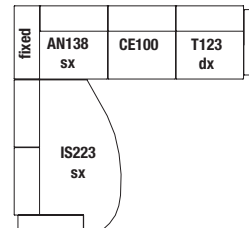

**TC23**

## DATASHEET

REGISTERED  
DESIGN

VII.2016

**molteni.it**

Dimensions in millimeters and inches. The right to discontinue and make changes is reserved. This information is based on the latest product information available at the time of printing.