

Molteni & C

FORTEPIANO — RODOLFO DORDONI 2011

1—
10



A system based on only three fundamental elements that can be freely combined together: floor or suspended storage units, modular shelves and display shelves. These simple ingredients enable the creation of infinite new solutions that are quick and fun to customize also thanks to a wide range of finishes: lacquers, wood and glass in various colours. An innovative system suitable for contemporary living that offers certain solutions for manifold living needs.

DATASHEET

REGISTERED
DESIGN

VII.2016

molteni.it

Dimensions in millimeters and inches. The right to discontinue and make changes is reserved. This information is based on the latest product information available at the time of printing.

FINISHES

	matt lacquer colours	coloured etched glass	woods	smoked glass/ extra clear transparent glass
modular shelves				
partitions				
storage units / open sided storage units				
structure				
wooden flap door				
wooden hinged door				
drawer				
glass flap door with shiny aluminium trim				
glass hinged door with shiny aluminium trim				
display shelves				

Molteni & C

2—
10

colours

Matt lacquer

BC chalk white
AV ivory
PE pearl
DN dune
PL platinum
PB lead
NE black
AT anthracite
SE mustard
SI silica
DO dolomite grey
AL clay
MK moka
CM caramel
CZ light blue grey
SA sand
RU ruby
CI cadmium
VB baltic green

Coloured etched glass

BC chalk white
PE pearl
DN dune
PL platinum
PB lead
NE black
AT anthracite
SE mustard
SI silica
DO dolomite grey
AL clay
MK moka
CM caramel
CZ light blue grey
SA sand
RU ruby
CI cadmium
VB baltic green

Woods

EU eucalyptus
RG grey oak
RF graphite oak
OC light elm
OS dark elm

DATASHEET

REGISTERED
DESIGN

VII.2016

molteni.it

Dimensions in millimeters and inches. The right to discontinue and make changes is reserved. This information is based on the latest product information available at the time of printing.

TECHNICAL INFORMATION

MODULAR SHELVES

Wood particleboard with melamine facing painted in the colours available in the “Molteni Range”.

STORAGE UNITS WITH DRAWER, HINGED OR FLAP DOOR, OPEN SIDED STORAGE UNITS

Wood particleboard with melamine facing painted in the colours available in the “Molteni Range”.

DISPLAY SHELF

Honeycomb core wood panel, finished with sliced Oak (Quercus), Elm (Ulmus rubra), Eucalyptus (Eucalyptus globulus) veneer or melamine and painted in the colours of the “Molteni Range”. Metal wall brackets.

COVERING PANEL

Chipboard panel, finished with sliced Oak, Elm, Eucalyptus veneer or melamine and painted in the colours of the “Molteni Range”.

UNDERTOP TRACK

Extruded anodised aluminium.

GLASS DOOR

Extruded anodised aluminium frame. 4 mm thick tempered etched coloured crystal.

PARTITION FOR MODULAR SHELVES

Tempered glass 8 mm th, or support made of medium density fibre board, with a 1 mm aluminium laminate, painted in the “Molteni Range” of colours.

DRAWER FOR PARTITIONS

Medium density fibre board with melamine facing, painted in the “Molteni Range” of colours.

SIDE AND INNER BOTTOM PANELS OF THE DRAWER

Particleboard panel, with melamine veneer.

MODULAR SHELVES

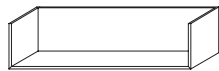

PARTITIONS FOR MODULAR SHELVES

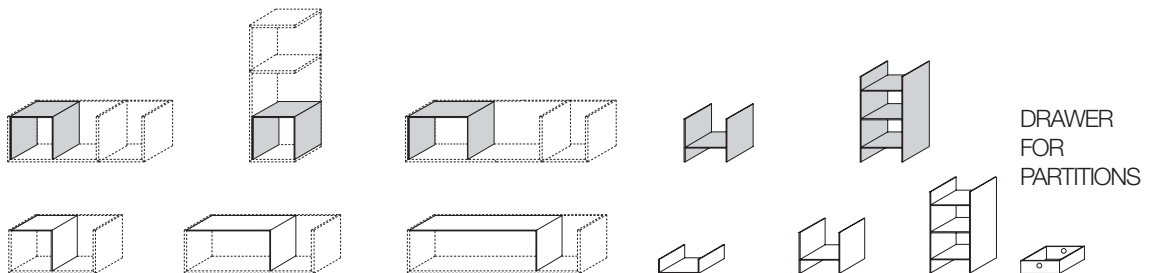

STORAGE UNITS WITH DRAWER, HINGED OR FLAP DOOR, OPEN SIDED STORAGE UNITS

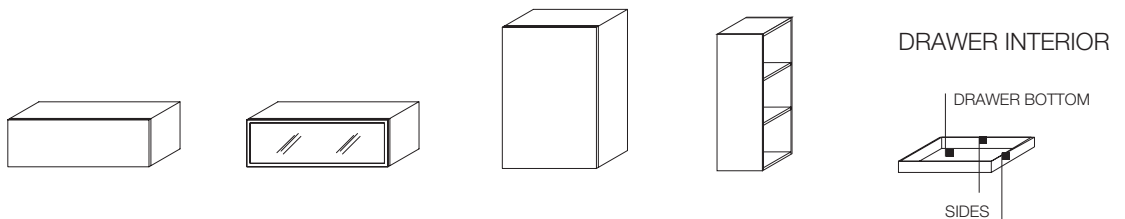

DISPLAY SHELF

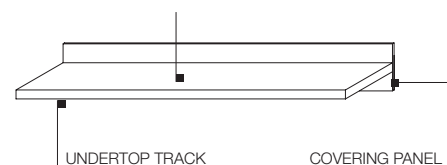

DATASHEET

REGISTERED
DESIGN

VII.2016

COMPOSITIONS EXAMPLES

Molteni & C

4—
 10

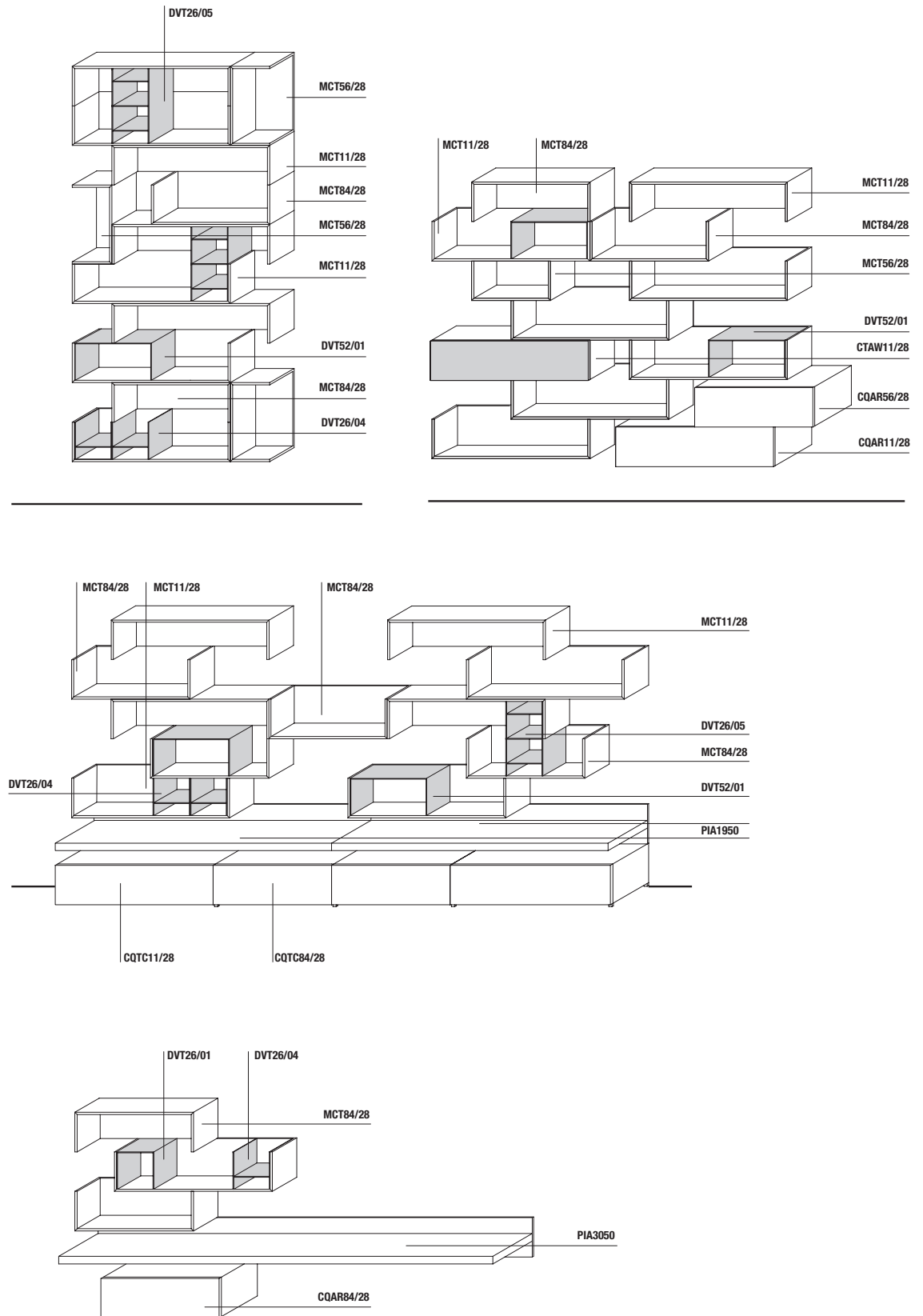

DATASHEET

REGISTERED
 DESIGN

VII.2016

DIMENSIONS

Modular shelves

Modular shelves can be freely suspended or joined together respecting the composition design, to create compositions articulated in their form and size.
 Each single shelf is predisposed for fixing to the wall in the direction required by the client and comes with the hardware necessary for all composition combinations.

single elements

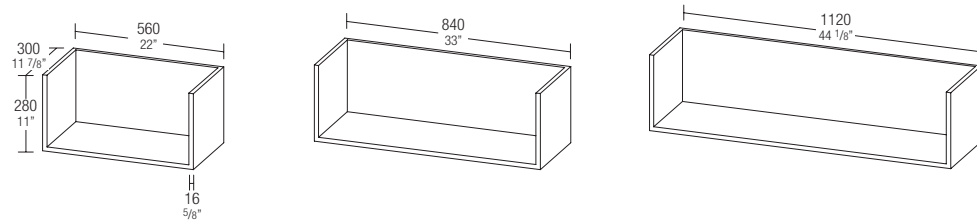

composition possibilities

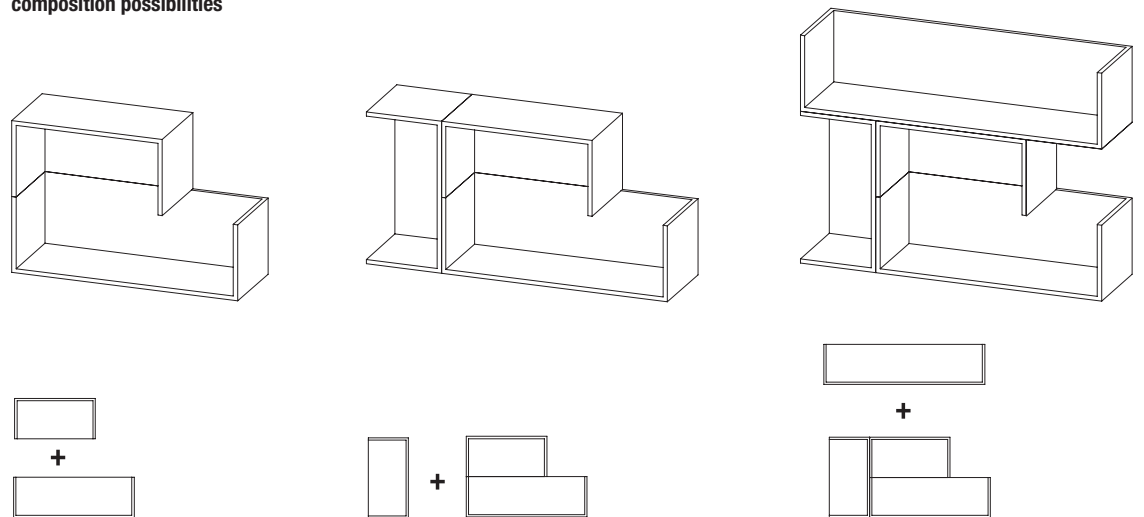

open sided storage unit

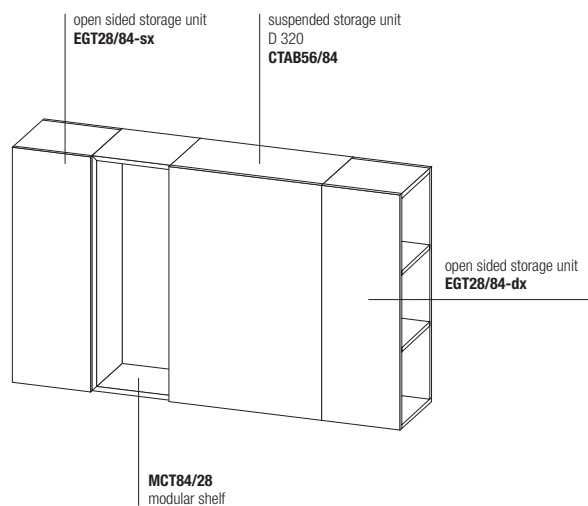

Molteni & C

5—
 10

DATASHEET

REGISTERED
 DESIGN

VII.2016

molteni.it

Dimensions in millimeters and inches. The right to discontinue and make changes is reserved. This information is based on the latest product information available at the time of printing.

DIMENSIONS

modular shelves
D 300 H 280 th 16
D 11 7/8" H 11" th 5/8"

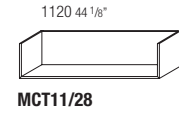
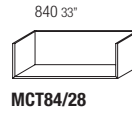
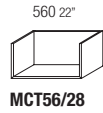

bridge partitions for modular shelves
D 282 H 263 th 6
D 11 1/8" H 10 3/8" th 3/8"

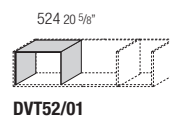
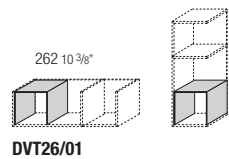

partitions for modular shelves
D 282 W 262 th 6
D 11 1/8" W 10 3/8" th 3/8"

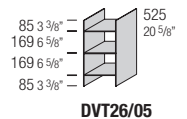
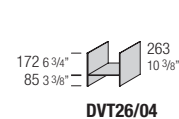

Molteni & C

6—
10

**bridge partitions
(resting on one partition)**
D 282 H 263 th 6
D 11 1/8" H 10 3/8" th 3/8"

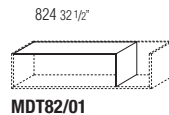
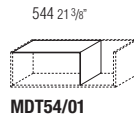
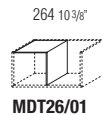

**drawer partitions
or trinket trays**
D 282 W 263 th 6
D 11 1/8" W 10 3/8" th 3/8"

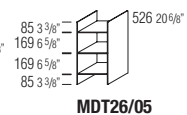
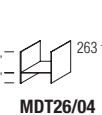
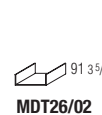

**drawer for
partitions**
D 282 W 249
H 83 th 6
D 11 1/8" W 9 3/4"
H 3 1/4" th 3/8"



SUSPENDED STORAGE UNITS D 320 / OPEN SIDED STORAGE UNIT

horizontal D 320 H 280 D 12 5/8" H 11"
with wooden flap door

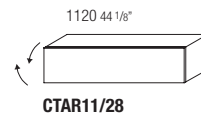
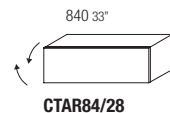
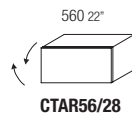

horizontal D 320 H 280 D 12 5/8" H 11"
with glass flap door

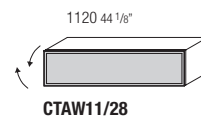
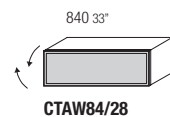
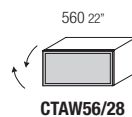

vertical D 320 W 280 D 12 5/8" W 11"
with wooden hinged door

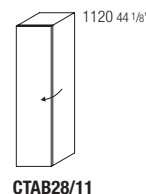
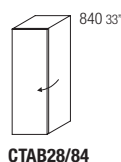

vertical D 320 W 280 D 12 5/8" W 11"
with glass hinged door

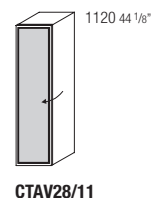
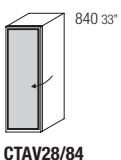

DATASHEET

REGISTERED
DESIGN

VII.2016

molteni.it

Dimensions in millimeters and inches. The right to discontinue and make changes is reserved. This information is based on the latest product information available at the time of printing.

DIMENSIONS

SUSPENDED STORAGE UNITS D 320 / OPEN SIDED STORAGE UNIT

vertical D 320 W 560 D 12 5/8" W 22"
with wooden hinged door

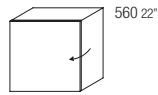

CTAB56/56

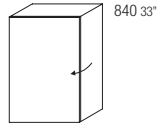

CTAB56/84

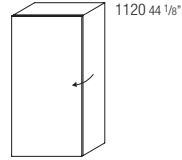

CTAB56/11

vertical D 320 W 560 D 12 5/8" W 22"
with glass hinged door

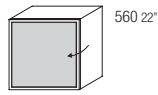

CTAV56/56

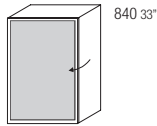

CTAV56/84

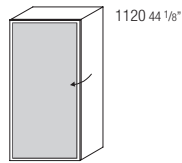

CTAV56/11

**left-sx or right-dx
 open sided storage unit
 D 320 W 280 D 12 5/8" W 11"**

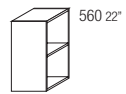

right-dx version
 EGT28/56

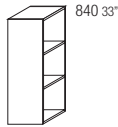

EGT28/84

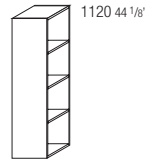

EGT28/11

SUSPENDED STORAGE UNITS D 470

horizontal D 470 H 280 D 18 1/2" H 11"
with wooden flap door

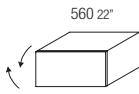

CQAR56/28

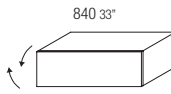

CQAR84/28

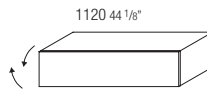

CQAR11/28

horizontal D 470 H 280 D 18 1/2" H 11"
with glass flap door

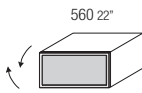

CQAW56/28

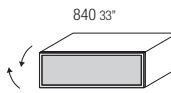

CQAW84/28

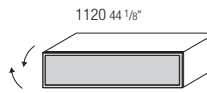

CQAW11/28

horizontal D 470 H 280 D 18 1/2" H 11"
with wooden drawer

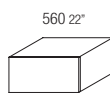

CQAC56/28

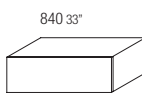

CQAC84/28

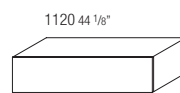

CQAC11/28

**wire passage for top of
 horizontal suspended
 storage units D 470
 W 112 D 57 W 4 3/8" D 2 1/4"**



EPA3

DIMENSIONS

SUSPENDED STORAGE UNITS D 470

vertical D 470 W 280 D 18 1/2" W 11"
with wooden hinged door

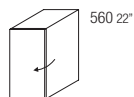

CQAB28/56

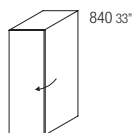

CQAB28/84

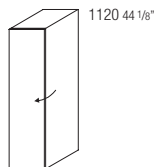

CQAB28/11

vertical D 470 W 280 D 18 1/2" W 11"
with glass hinged door

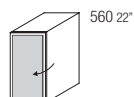

CQAV28/56

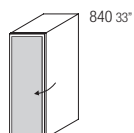

CQAV28/84

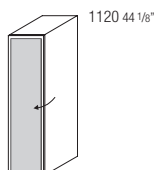

CQAV28/11

vertical D 470 W 560 D 18 1/2" W 22"
with wooden hinged door

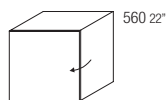

CQAB56/56

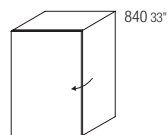

CQAB56/84

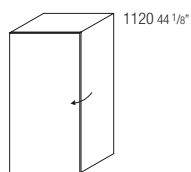

CQAB56/11

vertical D 470 W 560 D 18 1/2" W 22"
with glass hinged door

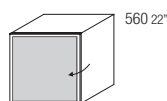

CQAV56/56

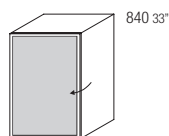

CQAV56/84

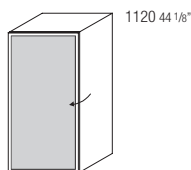

CQAV56/11

DIMENSIONS

FLOOR STANDING STORAGE UNITS D 470

horizontal D 470 H 300 D 18 1/2" H 11 3/4"
 with wooden flap door

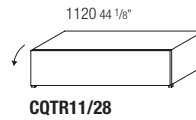
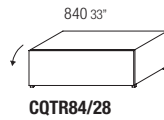
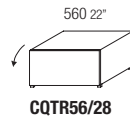

horizontal D 470 H 300 D 18 1/2" H 11 3/4"
 with glass flap door

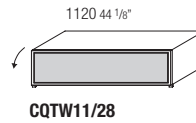
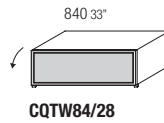
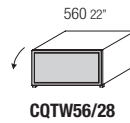

horizontal D 470 H 300 D 18 1/2" H 11 3/4"
 with wooden drawer

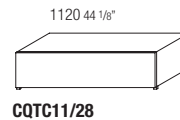
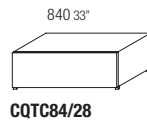
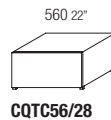

vertical D 470 W 280 D 18 1/2" W 11"
 with wooden hinged door

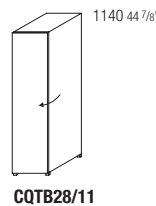

vertical D 470 W 280 D 18 1/2" W 11"
 with glass hinged door

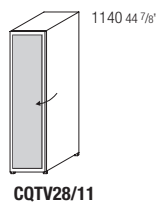
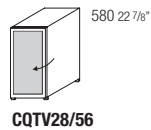

vertical D 470 W 560 D 18 1/2" W 22"
 with wooden hinged door

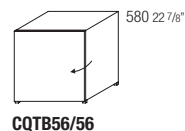

vertical D 470 W 560 D 18 1/2" W 22"
 with glass hinged door

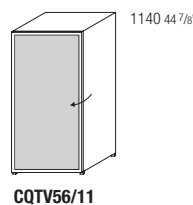
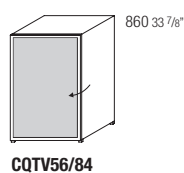
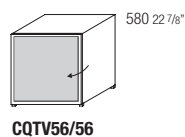

wire passage for top of
 horizontal floor standing
 storage units D 470
 W 112 D 57 W 4 3/8" D 2 1/4"



Molteni & C

DIMENSIONS

DISPLAY SHELVES D 500

Storage unit-shelf wiring diagram

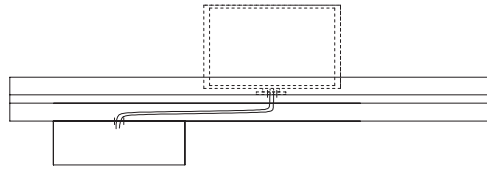

display shelves
D 500 H 280
D 19 5/8" H 11"
shelf th 53 mm

W 1400 W 55 1/8"

W 1960 W 77 1/8"

W 2520 W 99 1/4"

W 3080 W 121 1/4"

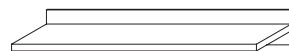

PIA14/50

PIA19/50

PIA25/50

PIA30/50

detachable undertop track

W 1400 W 55 1/8"

W 1960 W 77 1/8"

W 2520 W 99 1/4"

W 3080 W 121 1/4"

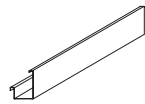
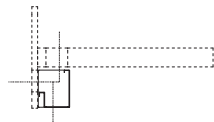

PCS14

PCS19

PCS25

PCS30

wire passage for display shelf
W 112 D 57
W 4 3/8" D 2 1/4"



EPA4

receiver system TV signals

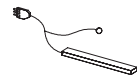

ETV1

drawer for attachment under display shelves



MGT26/01

positioning of the wire passage along the display shelf

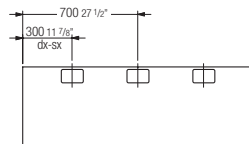

W 1400 W 55 1/8"

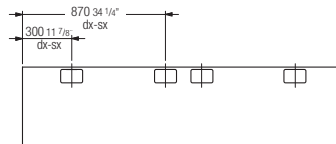

W 1960 W 77 1/8"

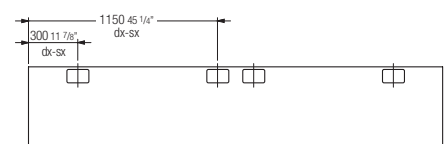

W 2520 W 99 1/4"

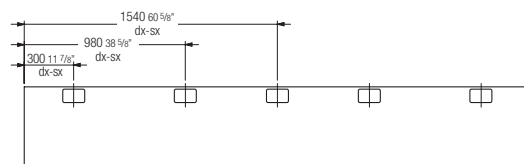

W 3080 W 121 1/4"

drawers positioning

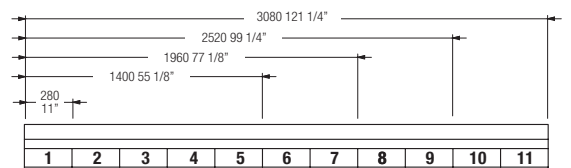

DATASHEET

REGISTERED
DESIGN

VII.2016

Molteni & C

FINISHES MOLTENI&C RANGE

IX.2016

	MATT LACQUER OPEN GRAIN LACQUER	GLOSSY LACQUER	COLOURED GLASS	ETCHED COLOURED GLASS	PLASTER LACQUERED CARTAPAGLIA LACQUERED <i>only Gliss Master</i>	STOPSOL
CHALK WHITE	•	•	•	•	•	
IVORY	•				•	
PEARL	•	•	•	•	•	
SILICA	•	•	•	•	•	
SAND	•	•	•	•	•	
PLATINUM	•	•	•	•	•	
DUNE	•	•	•	•	•	
CLAY	•	•	•	•	•	
DOLOMITE GREY	•	•	•	•	•	
RUBY	•	•	•	•	•	
CARAMEL	•	•	•	•	•	
MOKA	•	•	•	•	•	
MUSTARD	•	•	•	•	•	
CADMIUM	•	•	•	•	•	
LIGHT BLUE GREY	•	•	•	•	•	
BALTIC GREEN	•	•	•	•	•	
LEAD	•	•	•	•	•	
ANTHRACITE	•	•	•	•	•	
BLACK	•	•	•	•	•	
BRONZE				•		
GREY						•
LESSLESS RED <i>only matt lacquer</i>	•					

Molteni & C

FINISHES MOLTENI&C RANGE

IX.2016

WOODS

EUCALYPTUS

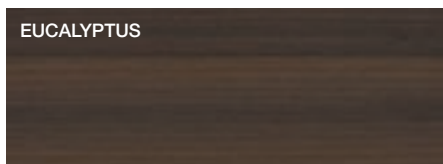

AMERICAN WALNUT



GRAPHITE OAK

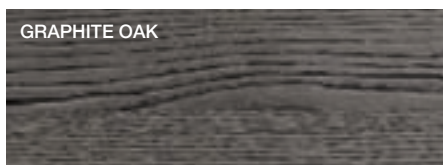

GREY OAK



BLACK OAK



DARK ELM



LIGHT ELM



CEDAR



MARBLES

WHITE CARRARA

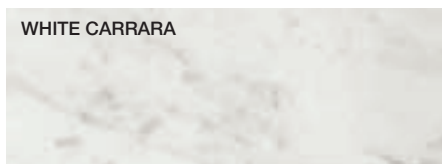

RED LAGUNA



EMPERADOR DARK

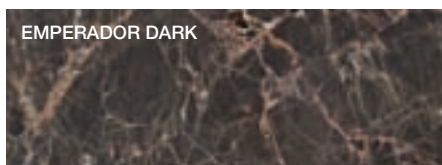

BLACK MARQUINA

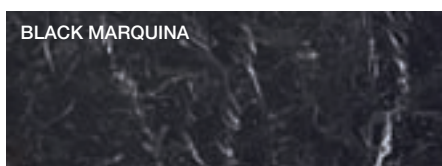

SAHARA NOIR



GRES

WHITE

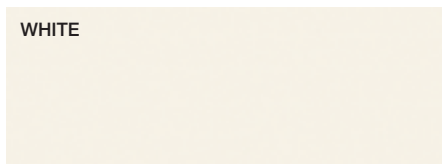

ANTHRACITE



METAL PARTS

BLACK CHROME

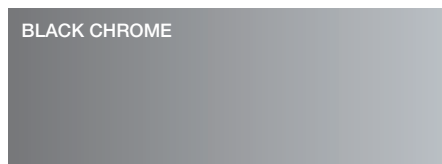

SHINY ALUMINIUM



PEWTER COLOUR

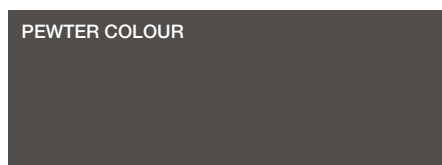

COPPER

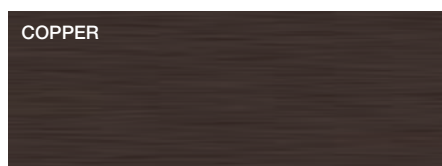

DWELL
DOOR FRAME, TRACK COVERING PROFILES

ANODISED ALUMINIUM



BROWN ALUMINIUM

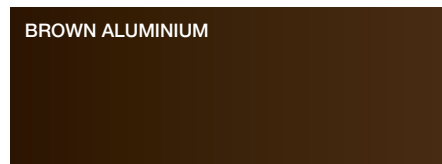

The finishes shown are indicative and refer to the entire production range. We recommend that you consult the "Colour Range" samples which shown the complete range of finishes, including those not shown here. Molteni&C reserves the right to modify the range without warning.