

Molteni & C

5050 — RODOLFO DORDONI 2016

1—
2



The wealth of materials used and a rigorous design are the elements that characterize 5050, a collection of bedroom furniture designed by Rodolfo Dordoni. Gloss or matt lacquered surfaces alternate with wooden tops and Eco Skin trays, creating alternating color effects that please the eye and underscore the play of solids and voids of a geometric design that is never banal. An interesting feature is the rounded contour of the structural elements that make up bedside tables and chests of drawers.

DATASHEET

REGISTERED
DESIGN

VII.2016

molteni.it

Dimensions in millimeters and inches. The right to discontinue and make changes is reserved. This information is based on the latest product information available at the time of printing.

FINISHES

SIDES, FRONTS AND BACK
matt lacquer colours in the Molteni colour range
glossy lacquer colours in the Molteni colour range

TOPS AND BASES
eucalyptus
grey oak
graphite oak

CHEST OF DRAWERS LOWER SHELF IN ECO SKIN
grey
mink
hemp
ivory
dark brown

TECHNICAL INFORMATION

TOP, STRUCTURE FOR DRAWER AND BASE
Chipboard panel covered in Eucalyptus wood (Eucalyptus Globulus) and Oak (Quercus) veneer.

LATERAL PIECES AND SHELVES, SIDES AND INTERNAL DRAWER BOTTOM
Chipboard panel covered in melamine facing.

LATERAL PIECES AND FRONTS
Medium density fibre panel covered in melamine facing, painted in Molteni range colours.

BACK
Chipboard panel covered in melamine facing, painted in Molteni range colours.

COVERED TOP
Chipboard panel covered in Eco Skin.

FRONT PIECE IN SOLID WOOD
In solid wood of the Large-leaved Linden (Tilia Platyphyllos) covered in Eucalyptus wood (Eucalyptus Globulus) and Oak (Quercus) veneer).

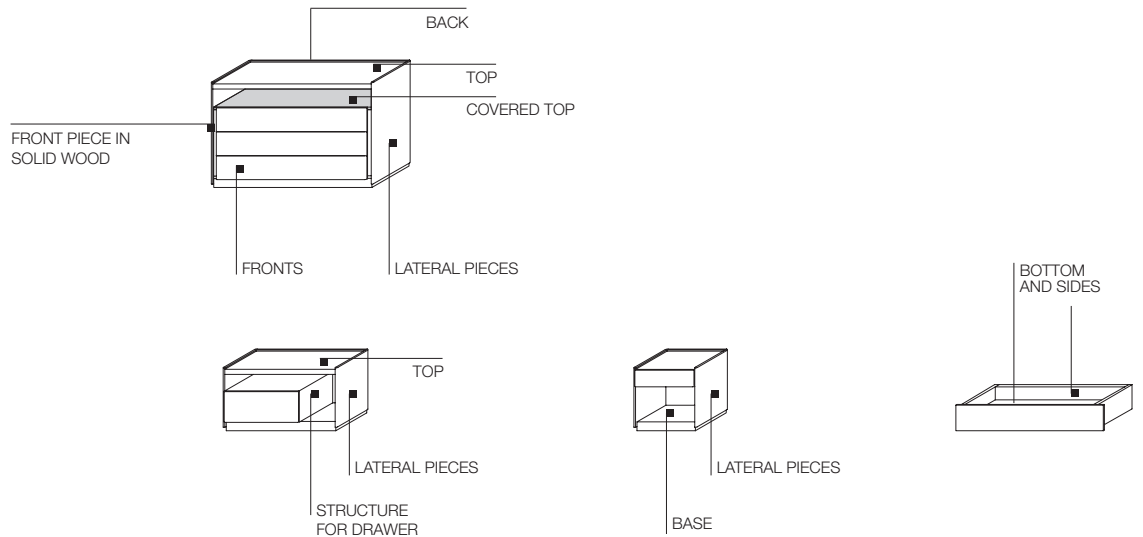

DIMENSIONS

night table
W 500 D 448 H 505
W 19 5/8" D 17 5/8" H 19 7/8"

night table
W 900 D 448 H 505
W 35 3/8" D 17 5/8" H 19 7/8"
drawer W 580 - 22 7/8"

chest of drawers
W 1277 D 538 H 850
W 50 1/4" D 21 1/8" H 33 1/2"

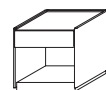

CCD1

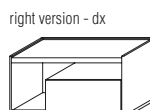

CCD2 dx - sx

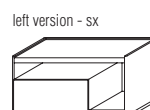

left version - sx

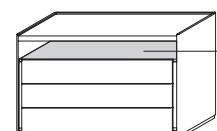

CCM1

lower shelf
Eco Skin
covered

Molteni & C

FINISHES MOLTENI&C RANGE

IX.2016

	MATT LACQUER OPEN GRAIN LACQUER	GLOSSY LACQUER	COLOURED GLASS	ETCHED COLOURED GLASS	PLASTER LACQUERED CARTAPAGLIA LACQUERED <i>only Gliss Master</i>	STOPSOL
CHALK WHITE	•	•	•	•	•	
IVORY	•				•	
PEARL	•	•	•	•	•	
SILICA	•	•	•	•	•	
SAND	•	•	•	•	•	
PLATINUM	•	•	•	•	•	
DUNE	•	•	•	•	•	
CLAY	•	•	•	•	•	
DOLOMITE GREY	•	•	•	•	•	
RUBY	•	•	•	•	•	
CARAMEL	•	•	•	•	•	
MOKA	•	•	•	•	•	
MUSTARD	•	•	•	•	•	
CADMIUM	•	•	•	•	•	
LIGHT BLUE GREY	•	•	•	•	•	
BALTIC GREEN	•	•	•	•	•	
LEAD	•	•	•	•	•	
ANTHRACITE	•	•	•	•	•	
BLACK	•	•	•	•	•	
BRONZE				•		
GREY						•
LESSLESS RED <i>only matt lacquer</i>	•					

Molteni & C

FINISHES MOLTENI&C RANGE

IX.2016

WOODS

EUCALYPTUS

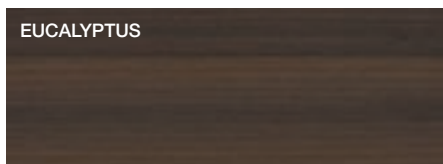

AMERICAN WALNUT



GRAPHITE OAK

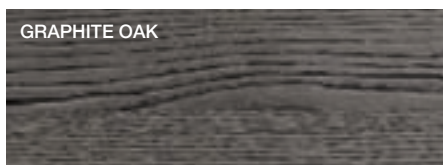

GREY OAK



BLACK OAK



DARK ELM



LIGHT ELM



CEDAR



MARBLES

WHITE CARRARA

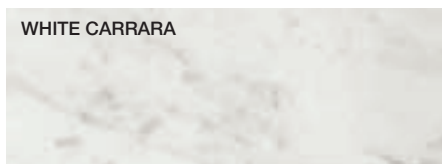

RED LAGUNA

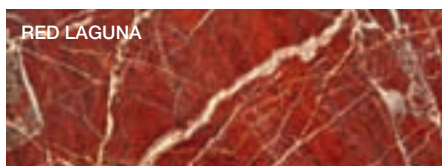

EMPERADOR DARK

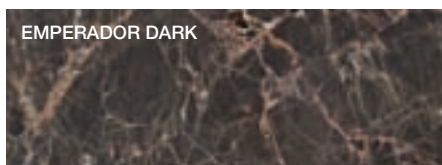

BLACK MARQUINA

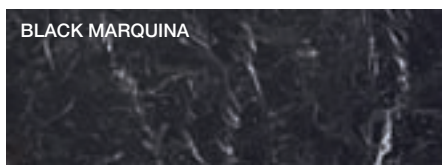

SAHARA NOIR



GRES

WHITE

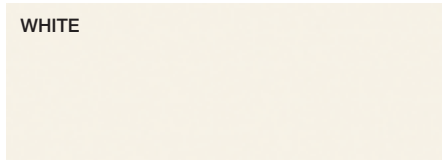

ANTHRACITE



METAL PARTS

BLACK CHROME

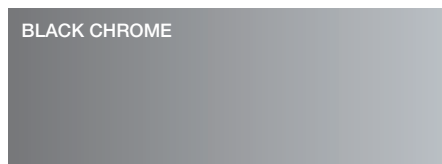

SHINY ALUMINIUM



PEWTER COLOUR

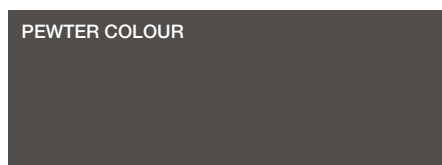

COPPER

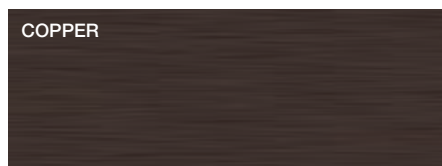

DWELL
DOOR FRAME, TRACK COVERING PROFILES

ANODISED ALUMINIUM



BROWN ALUMINIUM



The finishes shown are indicative and refer to the entire production range. We recommend that you consult the "Colour Range" samples which show the complete range of finishes, including those not shown here. Molteni&C reserves the right to modify the range without warning.

Molteni & C

FINISHES MOLTENI&C RANGE

IX.2016

CARTAPAGLIA

GLISS MASTER, GLISS WALK-IN FRONT

WHITE



ANTHRACITE



CARTAPAGLIA

GLISS MASTER FRONT

SILICA



PLASTER

GLISS MASTER FRONT

SILICA



MILLERIGHE

GLISS MASTER, GLISS WALK-IN STRUCTURE

DARK



MELAMINE STRUCTURE

GLISS MASTER, GLISS WALK-IN

WHITE SHANTUNG

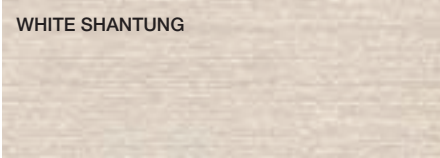

GREY SHANTUNG



SILVER CEMBRAN

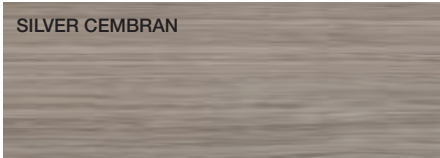

LARIX DARK

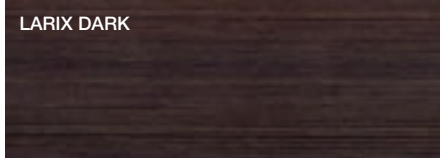

ECO SKIN

IVORY



HEMP



MINK



DARK BROWN



GREY

