

Molteni & C

606 — RODOLFO DORDONI 2010

1—
3



An articulated range of wooden drawer units with neat and elegant design, characterised by a remarkable breadth of finishes that make it a versatile product for any furnishing solution. A large family of storage units in wood, characterized by painted side inserts and frosted glass tops in nuances of colour that allow customers to create clear contrasts between frame and drawers, and also monochromatic units. Two versions of the base are available: the traditional floor standing base and the metal base which draws attention to the slender lines.

DATASHEET

REGISTERED
DESIGN

VII.2016

molteni.it

Dimensions in millimeters and inches. The right to discontinue and make changes is reserved. This information is based on the latest product information available at the time of printing.

FINISHES

DRAWER UNIT FINISHES

matt lacquer colours in the Molteni colour range - open grain lacquer colours in the Molteni colour range - eucalyptus - grey oak - graphite oak - light elm - dark elm.

The drawer units in matt lacquer and open grain lacquer can be fitted, on request, with a spacer in between structure and front in a different colour than the drawer unit itself.

GLASS TOP FINISH

coloured etched glass in the Molteni colour range

MARBLE TOP FINISHES

white Carrara - emperador dark - black marquina

METAL FRAME FINISH

shiny chrome - black chrome

TECHNICAL INFORMATION

INTERNAL STRUCTURE

Particleboard panel, coated with melamine resin.

EXTERNAL AND FRONT FINISH (MATT LACQUERED AND OPEN GRAIN VERSION)

Particleboard panel, coated with melamine resin and painted in shades from the "Molteni Range".

EXTERNAL AND FRONT FINISH (WOOD VERSION)

Particleboard panel veneered with sliced Oak (Quercus), Elm (Ulmus rubra) or Eucalyptus (Eucalyptus globulus).

FRAME

In chrome plated steel.

GLASS TOP

Glass (th. 8 mm), tempered, etched and coloured with the colours in the "Molteni Range".

MARBLE TOP

Marble in Range finishes with anti-stain, water-repellent treatments.

SPACER

MDF panel with wood veneer in Oak, Elm, Eucalyptus or with melamine paper facing painted in the "Molteni Range" colours.

SIDES AND INTERNAL DRAWER BOTTOM

Particleboard panel, coated with melamine resin.

ADJUSTABLE FEET

Non-skid plastic material.

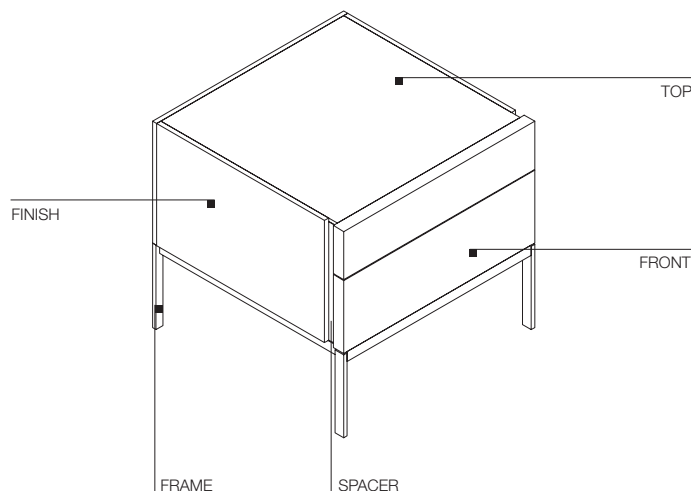

DIMENSIONS

Notes

- Standard version comes with partially extractable runners.
- Fully extractable runners on request.

bedside unit with 2 drawers

W 550 D 550 H 334

W 21 5/8" D 21 5/8" H 13 1/8"



glass top
SCZ2

marble top
SCZ2

drawer unit with 4 drawers

W 1200 D 550 H 764

W 47 1/4" D 21 5/8" H 29 7/8"

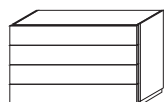

glass top
SCZ4

marble top
SCZ4

drawer unit with 7 drawers

W 550 D 550 H 1130

W 21 5/8" D 21 5/8" H 44 1/2"

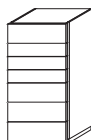

glass top
SCZ5

marble top
SCZ5

bedside unit with 2 drawers

W 550 D 550 H 514

W 21 5/8" D 21 5/8" H 20 1/4"



glass top
SCC2

marble top
SCC2

drawer unit with 3 drawers

W 1200 D 550 H 760

W 47 1/4" D 21 5/8" H 29 7/8"

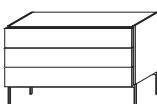

glass top
SCC3

marble top
SCC3

Molteni & C

FINISHES MOLTENI&C RANGE

IX.2016

	MATT LACQUER OPEN GRAIN LACQUER	GLOSSY LACQUER	COLOURED GLASS	ETCHED COLOURED GLASS	PLASTER LACQUERED CARTAPAGLIA LACQUERED <i>only Gliss Master</i>	STOPSOL
CHALK WHITE	•	•	•	•	•	
IVORY	•				•	
PEARL	•	•	•	•	•	
SILICA	•	•	•	•	•	
SAND	•	•	•	•	•	
PLATINUM	•	•	•	•	•	
DUNE	•	•	•	•	•	
CLAY	•	•	•	•	•	
DOLOMITE GREY	•	•	•	•	•	
RUBY	•	•	•	•	•	
CARAMEL	•	•	•	•	•	
MOKA	•	•	•	•	•	
MUSTARD	•	•	•	•	•	
CADMIUM	•	•	•	•	•	
LIGHT BLUE GREY	•	•	•	•	•	
BALTIC GREEN	•	•	•	•	•	
LEAD	•	•	•	•	•	
ANTHRACITE	•	•	•	•	•	
BLACK	•	•	•	•	•	
BRONZE				•		
GREY						•
LESSLESS RED <i>only matt lacquer</i>	•					

Molteni & C

FINISHES MOLTENI&C RANGE

IX.2016

WOODS

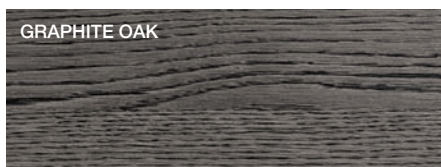
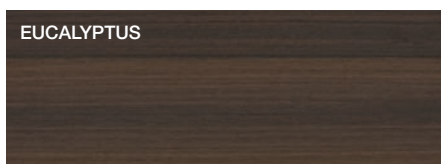

MARBLES

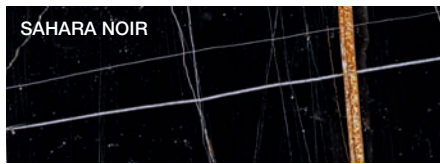
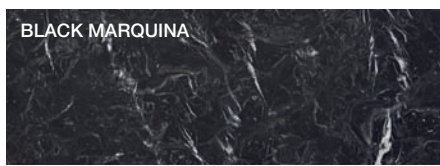
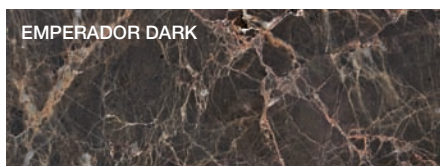
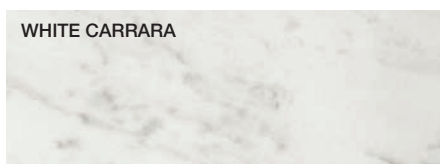

GRES

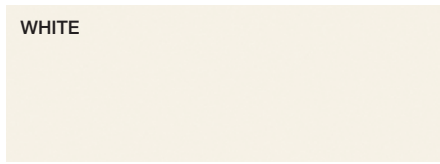

METAL PARTS

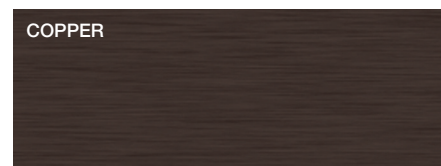
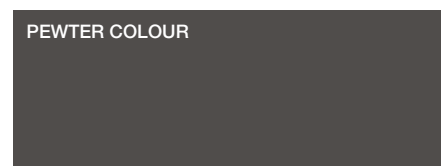
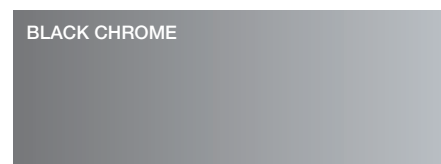

DWELL
DOOR FRAME, TRACK COVERING PROFILES



The finishes shown are indicative and refer to the entire production range. We recommend that you consult the "Colour Range" samples which shown the complete range of finishes, including those not shown here. Molteni&C reserves the right to modify the range without warning.