

# Molteni & C

## 909 — LUCA MEDA 1991

1—  
4



This is a line of modular chests of drawers whose elements can be used individually or combined to form a large container unit. It's a re-invention of the chest of drawers, standing between the rational and the traditional. Top in coloured glass, wood, glossy lacquered, matt or open grain lacquered. Drawers fronts in glossy lacquered, matt or open grain lacquered. A particular version with a refined open compartment and an aluminum structure supporting the drawers. Great care has been taken with the exterior matt or open grain lacquered finishes.

**DATASHEET**

REGISTERED  
DESIGN

VII.2016

**molteni.it**

Dimensions in millimeters and inches. The right to discontinue and make changes is reserved. This information is based on the latest product information available at the time of printing.

## FINISHES

### STRUCTURE FINISHES

matt lacquer colours in the Molteni colour range - open grain lacquer colours in the Molteni colour range

### DRAWER FINISHES

matt lacquer colours in the Molteni colour range - open grain lacquer colours in the Molteni colour range - glossy lacquer colours in the Molteni colour range

### TOP FINISHES

matt lacquer colours in the Molteni colour range - open grain lacquer colours in the Molteni colour range - glossy lacquer colours in the Molteni colour range - eucalyptus - grey oak - graphite oak - light elm - dark elm - coloured glass in the Molteni colour range - etched coloured glass in the Molteni colour range

### HANDLE AND INSERT OF THE PRESSURE-OPENING DOORS FINISH

shiny chrome

### LEGS FINISHES

black - shiny chrome

## TECHNICAL INFORMATION

### STRUCTURE AND FRONT

Wood particleboard with melamine facing painted in the colours available in the “Molteni Range”.

### SIDES AND INTERNAL DRAWER BOTTOM

Particleboard panel, coated with melamine resin.

### HANDLE

In chrome plated metal.

### OPEN COMPARTMENT

Frame in extruded anodised aluminium with tempered coloured etched glass (th.4mm). Adjustable metallic feet.

### GLASS TOP

Glass (th. 10mm), tempered coloured extralight or etched and coloured in the colours available in the “Molteni Range”.

### WOODEN TOP

MDF panel veneered with wood – Oak (Quercus), Elm (Ulmus rubra), Eucalyptus (Eucalyptus globulus) – or faced with melamine painted in the “Molteni Range” colours.

### ADJUSTABLE FEET

Non-skid plastic material.

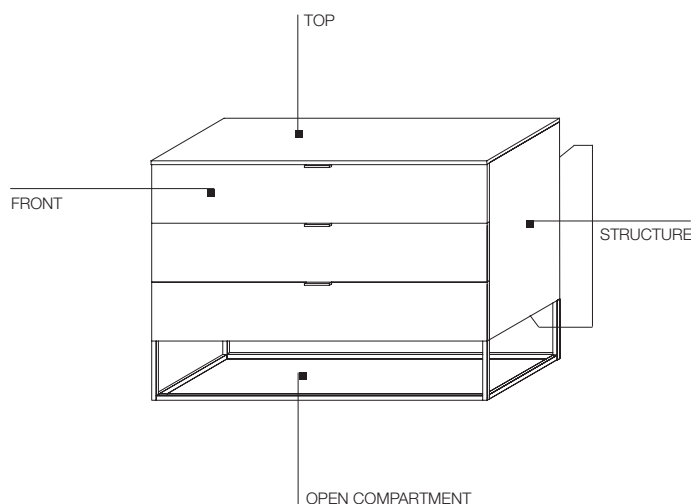

## DATASHEET

REGISTERED  
DESIGN

VII.2016

## DIMENSIONS

### Notes

- The finishing top is compulsory.
- Standard version comes with partially extractable runners.
- Fully extractable runners on request.

#### drawer unit with 1 drawer

W 480 D 480 H 342  
W 18 7/8" D 18 7/8" H 13 1/2"



handle  
**NCM4/16**

pressure-opening  
**NCP4/16**

#### drawer unit with 1 drawer

W 960 D 480 H 342  
W 37 3/4" D 18 7/8" H 13 1/2"



handle  
**NCM9/16**

pressure-opening  
**NCP9/16**

#### drawer unit with 2 drawers

W 480 D 480 H 340  
W 18 7/8" D 18 7/8" H 13 3/8"



handle  
**NTM4/32**

pressure-opening  
**NTP4/32**

#### drawer unit with 2 drawers

W 480 D 480 H 502  
W 18 7/8" D 18 7/8" H 19 3/4"



handle  
**NCM4/32**

pressure-opening  
**NCP4/32**

#### drawer unit with 2 drawers

W 960 D 480 H 340  
W 37 3/4" D 18 7/8" H 13 3/8"

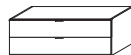

handle  
**NTM9/32**

pressure-opening  
**NTP9/32**

#### drawer unit with 2 drawers

W 960 D 480 H 502  
W 37 3/4" D 18 7/8" H 19 3/4"



handle  
**NCM9/32**

pressure-opening  
**NCP9/32**

#### drawer unit with 3 drawers

W 480 D 480 H 500  
W 18 7/8" D 18 7/8" H 19 3/4"



handle  
**NTM4/48**

pressure-opening  
**NTP4/48**

#### drawer unit with 3 drawers

W 480 D 480 H 662  
W 18 7/8" D 18 7/8" H 26"



handle  
**NCM4/48**

pressure-opening  
**NCP4/48**

#### drawer unit with 3 drawers

W 960 D 480 H 500  
W 37 3/4" D 18 7/8" H 19 3/4"

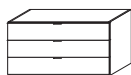

handle  
**NTM9/48**

pressure-opening  
**NTP9/48**

#### drawer unit with 3 drawers

W 960 D 480 H 662  
W 37 3/4" D 18 7/8" H 26"



handle  
**NCM9/48**

pressure-opening  
**NCP9/48**

**DIMENSIONS**

**drawer unit with 3 drawers**

W 960 D 480 H 660  
W 37 3/4" D 18 7/8" H 26"

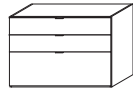

handle  
**NTM9/64/3**      pressure-opening  
**NTP9/64/3**

**drawer unit with 3 drawers**

W 960 D 480 H 822  
W 37 3/4" D 18 7/8" H 32 3/8"

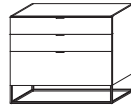

handle  
**NCM9/64/3**      pressure-opening  
**NCP9/64/3**

**drawer unit with 4 drawers**

W 960 D 480 H 660  
W 37 3/4" D 18 7/8" H 26"



handle  
**NTM9/64/4**      pressure-opening  
**NTP9/64/4**

**drawer unit with 4 drawers**

W 960 D 480 H 822  
W 37 3/4" D 18 7/8" H 32 3/8"

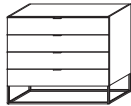

handle  
**NCM9/64/4**      pressure-opening  
**NCP9/64/4**

**drawer unit with 5 drawers**

W 480 D 480 H 980  
W 18 7/8" D 18 7/8" H 38 5/8"



handle  
**NTM4/96**      pressure-opening  
**NTP4/96**

**drawer unit with 5 drawers**

W 960 D 480 H 980  
W 37 3/4" D 18 7/8" H 38 5/8"

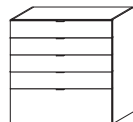

handle  
**NTM9/96**      pressure-opening  
**NTP9/96**

**led lighting system**  
for open compartment

**finishing tops**

D 484 th 10  
D 19" th 3/8"



**TOQ48**

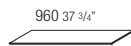

**TOQ96**

for W 480 18 7/8"



**HLG48**

for W 960 37 3/4"

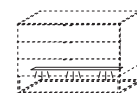

**HLG96**

# Molteni & C

## FINISHES MOLTENI&C RANGE

IX.2016

	MATT LACQUER OPEN GRAIN LACQUER	GLOSSY LACQUER	COLOURED GLASS	ETCHED COLOURED GLASS	PLASTER LACQUERED CARTAPAGLIA LACQUERED <i>only Gliss Master</i>	STOPSOL
CHALK WHITE	•	•	•	•	•	
IVORY	•				•	
PEARL	•	•	•	•	•	
SILICA	•	•	•	•	•	
SAND	•	•	•	•	•	
PLATINUM	•	•	•	•	•	
DUNE	•	•	•	•	•	
CLAY	•	•	•	•	•	
DOLOMITE GREY	•	•	•	•	•	
RUBY	•	•	•	•	•	
CARAMEL	•	•	•	•	•	
MOKA	•	•	•	•	•	
MUSTARD	•	•	•	•	•	
CADMIUM	•	•	•	•	•	
LIGHT BLUE GREY	•	•	•	•	•	
BALTIC GREEN	•	•	•	•	•	
LEAD	•	•	•	•	•	
ANTHRACITE	•	•	•	•	•	
BLACK	•	•	•	•	•	
BRONZE				•		
GREY						•
LESSLESS RED <i>only matt lacquer</i>	•					

# Molteni & C

## FINISHES MOLTENI&C RANGE

IX.2016

### WOODS

EUCALYPTUS

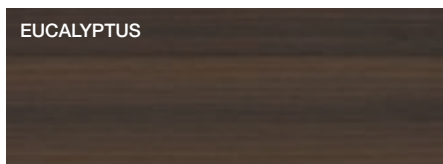

AMERICAN WALNUT



GRAPHITE OAK

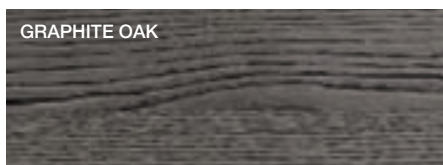

GREY OAK



BLACK OAK



DARK ELM



LIGHT ELM



CEDAR



### MARBLES

WHITE CARRARA

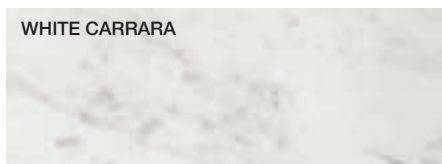

RED LAGUNA

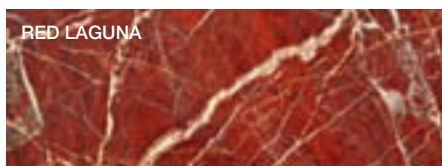

EMPERADOR DARK

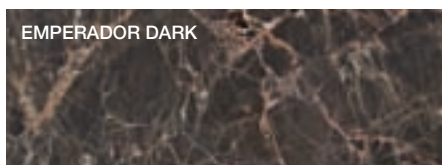

BLACK MARQUINA

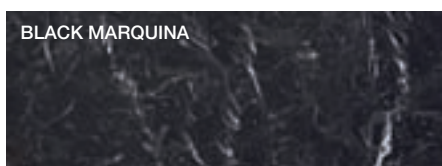

SAHARA NOIR



### GRES

WHITE

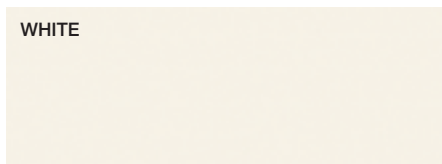

ANTHRACITE



### METAL PARTS

BLACK CHROME

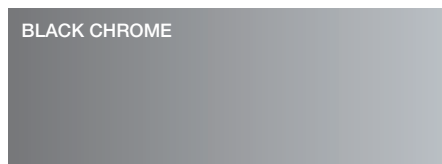

SHINY ALUMINIUM



PEWTER COLOUR

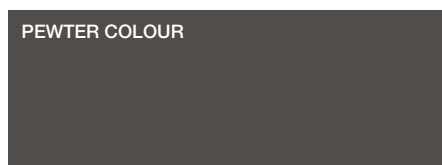

COPPER

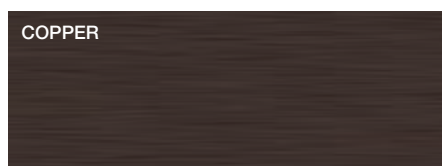

DWELL  
DOOR FRAME, TRACK COVERING PROFILES

ANODISED ALUMINIUM

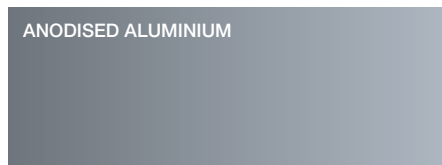

BROWN ALUMINIUM

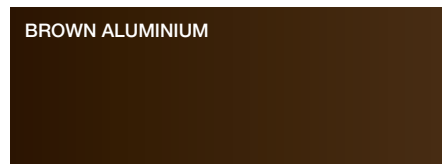

The finishes shown are indicative and refer to the entire production range. We recommend that you consult the "Colour Range" samples which shown the complete range of finishes, including those not shown here. Molteni&C reserves the right to modify the range without warning.