

ANDERSEN

DESIGN RODOLFO DORDONI



Struttura: in legno tamburato monoscocca.

Preparazione della struttura: in poliuretano espanso a quote differenziate ad alta densità.

Cuscineria: imbottitura cuscino seduta in piuma d'oca canalizzata ad alto spessore per conferire grande sofficietà al cuscino. Inserto in poliuretano espanso ad alta resilienza, rivestito nella parte superiore con materiale poliuretano "termosensibile". Cuscini schienale totalmente imbottiti in piuma d'oca canalizzata.

Braccioli: rivestiti sul lato interno con trapuntino in piuma d'oca canalizzata che conferisce morbidezza, dando al bracciolo l'aspetto di un cuscino.

Base: realizzata con telaio in metallo a sezione rettangolare 30x15 mm con finitura color Peltro (tonalità ideata da Minotti Studio). Appoggio a terra tramite piedini (disegnati e progettati da Minotti Studio) stampati in metallo pressofuso colore Peltro con finitura extra-lucida anti-touch. Questi piedini sono in grado di resistere a circa 300 ore di nebbia salina (salsedine marina) e sono resistenti a graffi, sostanze chimiche, urti (data la loro notevole plasticità) e ai raggi ultravioletti. Scivolante protettivo in Hytrel® (gomma morbida antigraffio).

Sfoderabilità: il rivestimento è completamente sfoderabile nella versione in tessuto smontando la base perimetrale portante allentando le apposite manopole. Nella versione in pelle il rivestimento è fisso solo per la struttura, mentre è sfoderabile per i cuscini schienale e seduta.

Optional: cuscino poggiatesta realizzato in poliuretano espanso ad elevata densità rivestito con trapuntino in piuma d'oca canalizzata e fissato alla struttura mediante fascia. La fodera del cuscino può essere realizzata a scelta nei tessuti o pelli a campionario, qualora non venisse specificata all'atto dell'ordine verrà coordinata al rivestimento del divano. Il poggiatesta si può collocare in diverse posizioni a seconda delle varie esigenze di utilizzo.

Structure: one-piece sandwich wood frame.

Structure preparation: let into high-density polyurethane foam in different densities.

Cushions: thick seat cushion padding in goose down divided into sections, for increased cushion softness. Resilient polyurethane foam insert, covered - in the upper part - with "thermosensitive" polyurethane material. Backrest cushions fully padded with goose down divided into sections.

Armrests: internal side covered with quilted goose down divided into sections, which results in enhanced softness, thereby making the armrests look like cushions.

Base: fitted with metal frame, rectangular section, 30x15 mm; Pewter-colored finish (shade devised by Minotti Studio). Feet (designed by Minotti Studio), die-cast metal pressed, Pewter-colored; ultra-glossy, anti-touch finish. These feet can withstand saline mist (sea salt) for approximately 300 hours and are resistant to scratches, chemical substances, shocks (due to their plasticity) and UV rays. Protective glides made of Hytrel® (soft, scratch-proof rubber).

Covers: fully removable in the fabric version by taking the external supporting base apart, loosening the knobs. Leather cover of the structure non-removable; removable backrest and seat cushion covers.

Optional: headrest cushion made of high-density polyurethane foam, covered with quilted goose down divided into sections and fixed to the frame by means of a strip. The cushion cover can be supplied in the fabrics or types of leather available in the pattern book. If the material of the cushion cover is not specified in the order, it will be coordinated with the sofa cover. The headrest can be placed in several positions, to satisfy individual requirements.

Gestell: aus Sperrholzschalen.

Aufbereitung des Gestells: mit unterschiedlich dick geschäumtem, hochdichtem Polyurethan.

Kissen: Dickes Sitzkissenpolster aus kanalisierten Gänsedaunen, durch die das Kissen sehr locker wirkt. Einsatz aus hoch kerbzähem, geschäumtem Polyurethan und Oberseitenpolsterung mit "wärmesensiblen" Polyurethanmaterial. Komplet mit kanalisierten Gänsedaunen gefütterte Rückenlehnenkissen.

Armlehne: an der Innenseite mit einem Steppbezug aus kanalisierten Gänsedaunen bezogene Armlehnen, die weich und locker wirken, was der Armlehne das Aussehen eines Kissens verleiht.

Grundgestell: aus einem Metallrahmen mit rechteckigem Schnitt 30x15 mm und zinnfarbenen Finish (von Minotti Studio erfundener Farbton). Bodenaufgabe durch (von Minotti Studio entworfene und entwickelte) Füße, die im Metall-druckgussverfahren gegossen und mit einem zinnfarbenen Extraglanzack endgefertigt werden. Diese Füße sind ungefähr 300 Stunden gegen Salznebel (Meeressalz) beständig und sind kratzsicher, chemikalienbeständig, stoßfest (aufgrund ihrer herausragenden Formbarkeit) und UV-strahlenbeständig. Gleitschutz aus Hytrel® (weicher, kratzfester Gummi).

Abziehbarkeit: Nur der Stoffbezug ist abziehbar. Hierzu wird das umlaufende tragende Grundgestell nach vorheriger Lockerung der Kugelgriffe demontiert. Fester Lederbezug nur für das Gestell.

Optional: Kopfstützenkissen aus geschäumtem, hochdichtem Polyurethan. Steppbezug aus kanalisierten Gänsedaunen und Befestigung am Gestell durch ein Band. Der Kissenbezug kann aus den Stoffen oder dem Leder, die in der Musterkollektion zur Auswahl stehen, gefertigt werden; wird der Kissenbezug nicht auf der Bestellung angegeben, so wird er auf den Sofabezug abgestimmt. Die Kopfstütze lässt sich je nach Nutzungsanspruch in unterschiedliche Positionen stellen.

Structure : en bois contreplaqué monocoque.

Préparation de la structure : en polyuréthane expansé à hauteurs différenciées haute densité.

Coussins : le rembourrage du coussin d'assise en plumes d'oie à secteurs à haute épaisseur confère une grande souplesse au coussin. Élément en polyuréthane expansé à haute résilience, revêtu dans la partie supérieure avec un matériau polyuréthane "thermosensible". Les coussins du dossier sont entièrement rembourrés en plumes d'oie à secteurs.

Accoudoirs : le côté intérieur est matelassé en plumes d'oie à secteurs pour plus de douceur et de moelleux, ce qui les transforme en de véritables coussins.

Base : réalisée avec châssis en métal de section rectangulaire 30x15 mm avec finition couleur Étain (tonalité conçue par Minotti Studio). Piètement (conçu et réalisé par Minotti Studio) en acier moulé sous pression, couleur Étain avec finition ultra brillante anti-touch. Piètement résistant à environ 300 heures de brouillard salin (salinité marine), aux éraflures, aux substances chimiques, aux chocs (en raison de leur incroyable plasticité) et aux rayons ultraviolets. Pâtin de protection en Hytrel® (caoutchouc souple antiéraflure).

Déhoussage : revêtement entièrement déhoussable en tissu après démontage de la base périmétrale porteuse en desserrant les boutons moletés. Revêtement en cuir fixe pour la structure, coussins dossier et d'assise déhoussables uniquement.

Optionnel : réalisé en polyuréthane expansé haute densité, revêtement matelassé en plumes d'oie à secteurs et fixation à la structure à l'aide d'une sangle. La doublure du coussin peut être réalisée au choix parmi la gamme de tissus et cuirs sur catalogue ; en l'absence de spécification à la commande, le coussin sera coordonné au revêtement du divan. Le repose-tête peut être placé en différentes positions en fonction des différentes exigences d'utilisation.

FINITURA BASE BASE FINISH

METALLO | METAL

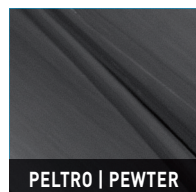

PELTRO | PEWTER

POLTRONA | ARMCHAIR

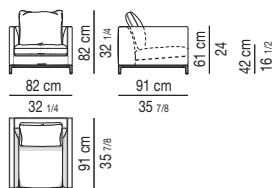

DIVANO | SOFA

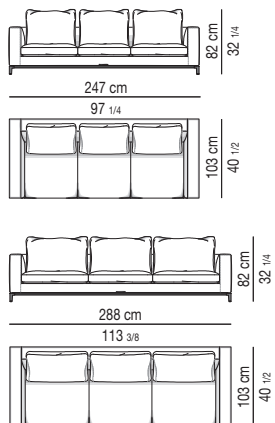
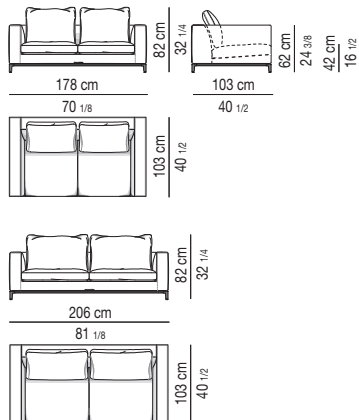

CON 3 CUSCINI
DI SEDUTA
WITH 3 SEAT
CUSHIONS

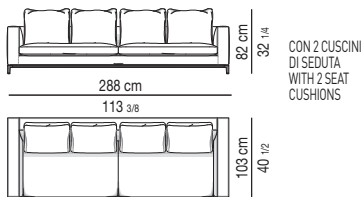

CON 2 CUSCINI
DI SEDUTA
WITH 2 SEAT
CUSHIONS

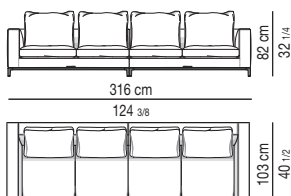

divano composto | two elements sofa

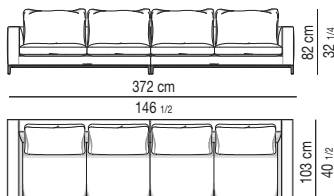

divano composto | two elements sofa

ELEMENTO TERMINALE | ELEMENT WITH 1 ARMREST

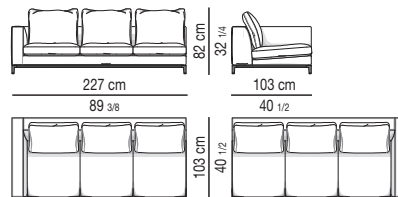
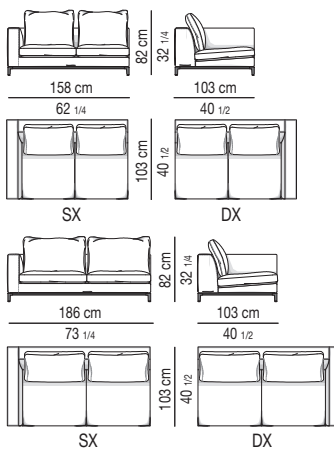

SX

DX

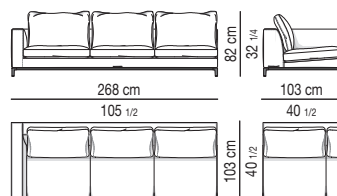

SX

DX

DIVANO ANGOLARE | CORNER SOFA

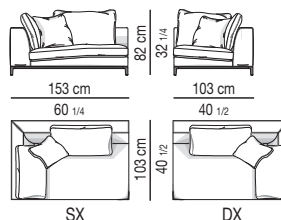

ELEMENTO CENTRALE | CENTRAL ELEMENT

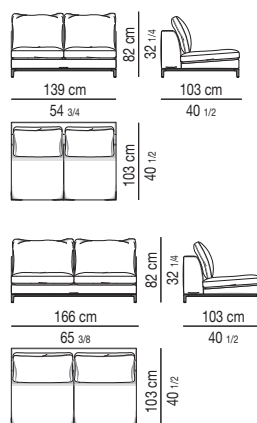

ESEMPIO AGGREGABILITÀ DI DIVANO ANGOLARE, ELEMENTO CENTRALE E POUF
EXAMPLE OF CORNER SOFA, CENTRAL ELEMENT AND OTTOMAN SETTING SOLUTION

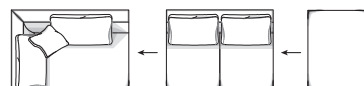

ELEMENTO ANGOLARE | CORNER ELEMENT

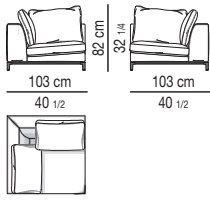

DIVANO TERMINALE ANGOLARE | CORNER SOFA WITH 1 ARMRE:

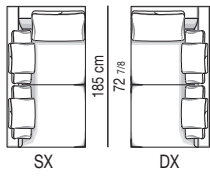
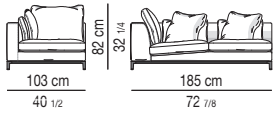

SX

DX

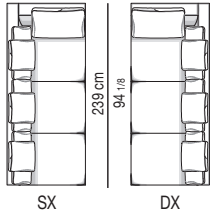
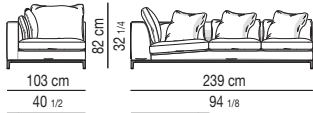

SX

DX

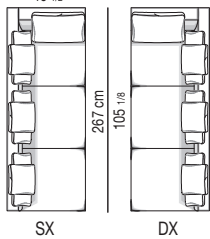
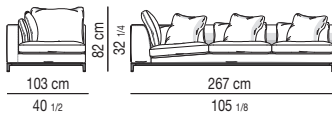

SX

DX

DIVANO ANGOLARE PENISOLA | OPEN-END CORNER SOFA

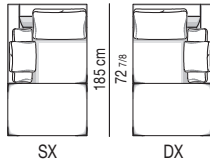
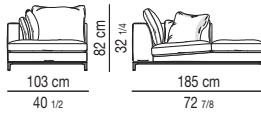

SX

DX

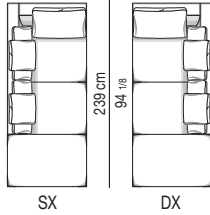
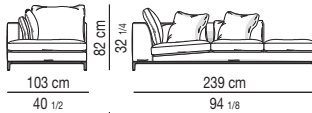

SX

DX

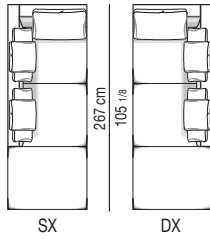
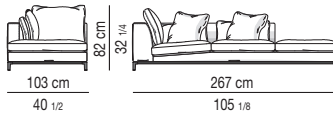

SX

DX

POUF | OTTOMAN

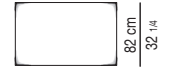
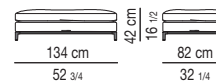
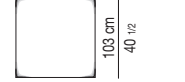
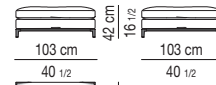
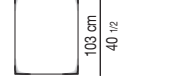
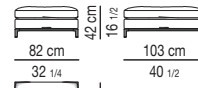
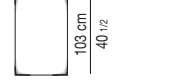
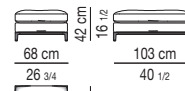

ELEMENTO "SOFA" | "SOFA" ELEMENT

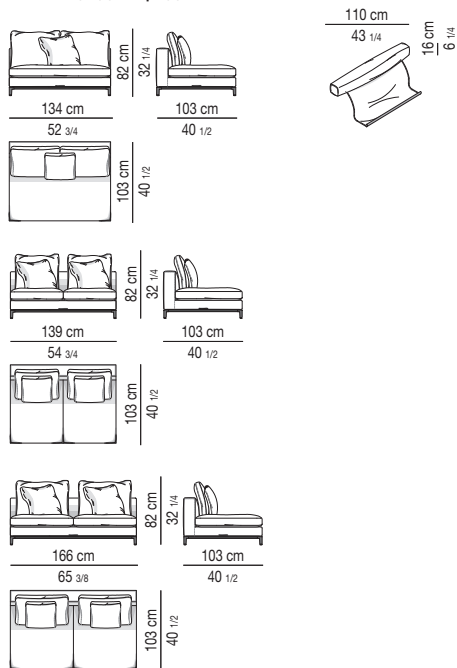

ELEMENTO "SOFA" CON PENISOLA OPEN-END "SOFA" ELEMENT

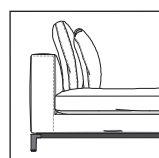
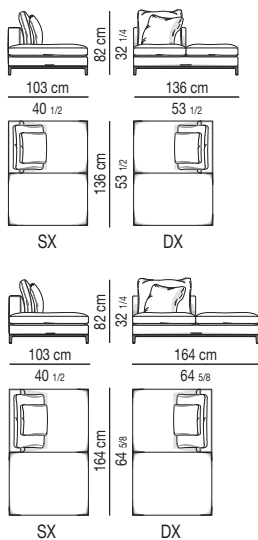

SEZIONE DELLO SCHIENALE E DEL BRACCIOLO
DEGLI ELEMENTI "SOFA".

BACKREST AND ARMREST'S SECTION OF
THE "SOFA" ELEMENTS.

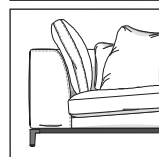

SEZIONE DELLO SCHIENALE DI "DIVANI",
"ELEMENTI TERMINALI", "DIVANO ANGOLARE",
"ELEMENTI CENTRALI", "DIVANI ANGOLARI
PENISOLA" E "DIVANI TERMINALI ANGOLARI".

BACKREST'S SECTION OF "SOFAS", "ELEMENTS
WITH 1 ARMREST", "CORNER SOFA",
"CENTRAL ELEMENTS", "OPEN-END CORNER
SOFAS" AND "CORNER SOFAS WITH 1 ARMREST".

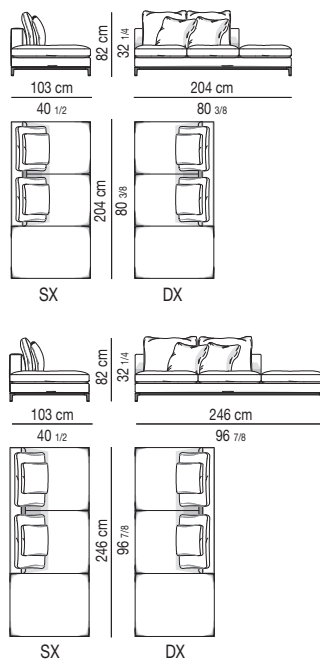

ELEMENTO "SOFA" CON 1 BRACCIOLO "SOFA" ELEMENT WITH 1 ARMREST

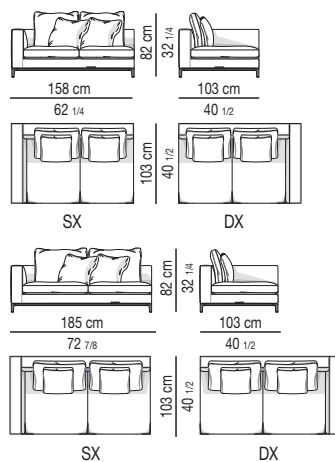

ELEMENTO "SOFA" PENISOLA CON 1 BRACCIOLO OPEN-END "SOFA" ELEMENT WITH 1 ARMREST

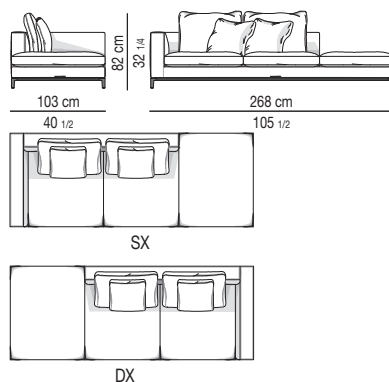

PANCA | BENCH

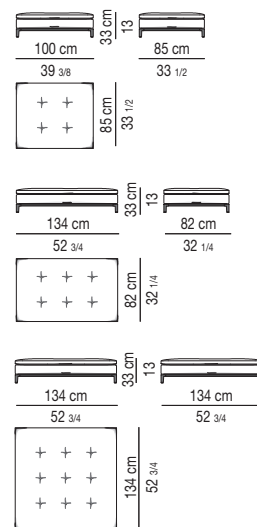

CUSCINO-PANCA | BENCH-CUSHION

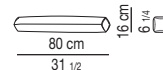

CUSCINO OPTIONAL OPTIONAL CUSHION

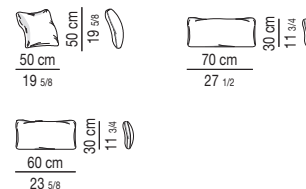

POGGIATESTA OPTIONAL OPTIONAL HEADREST

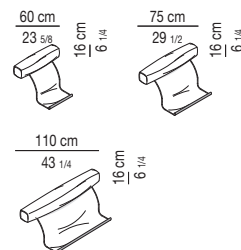

POSIZIONE POGGIATESTA | HEADREST POSITION

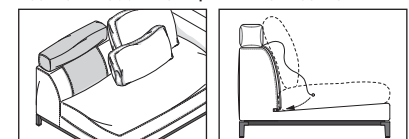

N.B.: GLI ELEMENTI "SOFA" NON POSSONO ESSERE AGGREGATI AI "DIVANI ANGOLARI PENISOLA" E AI "DIVANI TERMINALI ANGOLARI" PER LA DIFFERENTE SEZIONE DELLO SCHIENALE. GLI ELEMENTI "SOFA" CON 1 BRACCIOLO (CM 158 E 185) E GLI ELEMENTI "SOFA" PENISOLA CON 1 BRACCIOLO (CM 268) POSSONO ESSERE AGGREGATI ESCLUSIVAMENTE AGLI ALTRI ELEMENTI "SOFA".

N.B.: "SOFA" ELEMENTS CANNOT BE JOINED TO "OPEN-END CORNER SOFAS" AND TO "CORNER SOFAS WITH 1 ARMREST" DUE TO THE DIFFERENT SECTION OF THE BACKREST. THE "SOFA" ELEMENTS WITH 1 ARMREST (CM 158 AND 185) AND THE OPEN-END "SOFA" ELEMENTS WITH 1 ARMREST (CM 268) CAN BE JOINED ONLY TO THE OTHER "SOFA" ELEMENTS.