

HAMILTON ISLANDS

DESIGN RODOLFO DORDONI



Struttura: in metallo. Struttura schienale e braccioli in legno.

Preparazione della struttura: poliuretano espanso a quote differenziate e ad alta resilienza. Prima foderatura in fibra termolegata con tela di cotone bianca.

Cinghie: cinghie elastiche intrecciate ad alta componente di caucciù.

Cuscinatura: imbottitura cuscini seduta e schienale in piuma d'oca canalizzata con inserto in poliuretano ad alta resilienza.

Base: realizzata con telaio in metallo a sezione ovale 40x20 mm con finitura Black-Nickel lucida e scivolanti protettivi in PVC.

Sfoderabilità: il rivestimento è completamente sfoderabile nella versione in tessuto smontando la base perimetrale, mentre è fisso nella versione in pelle.

N.B.: con il rivestimento in pelle le cuciture dei cuscini sono posizionate a seconda delle forme e delle dimensioni in maniera differente dagli elementi rivestiti in tessuto.

Optional: vassoio 50x30 cm e 80x30 cm in cuoio nei colori Moka e Nero.

Structure: in metal. Wood armrests and backs structure.

Structure preparation: high resilience polyurethane foam of various densities. First lining made from fibre thermally bound to white cotton cloth.

Straps: woven elastic straps with a high rubber content.

Cushions: seat and back cushions padded with goose down divided into sections, with high resilience polyurethane inset.

Base: with metal frame oval section 40x20 mm, glossy Black-Nickel finish with protective PVC glides.

Covers: fully removable in the fabric version by taking the external supporting base apart, non-removable in the leather version.

N.B.: depending on the various shapes and sizes, the stitching position of the cushions in the leather version will change from the ones in the fabric version.

Optional: tray 50x30 cm and 80x30 cm in saddle-hide available in Moka and Black color.

Gestell: Struktur aus Metall, Rücken- und Armlehnen aus Holz.

Aufbereitung des Gestells: aus hochwiderstandsfähigem Polyurethanschaum in unterschiedlicher Dichte. Der erste Bezug ist aus Wärmegebundener, auf weissem Baumwollgewebe aufkaschierter Faser.

Riemen: verflochtene Elastikriemen mit hoher Kautschukkomponente.

Kissen: Sitz- und Rückenkissenfüllung aus kanalisiertem Gänsedaunen mit hochwiderstandsfähigem Polyurethan-kern.

Grundgestell: aus Metall mit ovalem Querschnitt 40x20 mm, Ausführung: Black-Nickel hochglänzend, mit PVC gleitern.

Abziehbarkeit: nur Stoffbezug abnehmbar. Hierzu die Metalluntergestelle abmontieren. Der Lederbezug ist fix montiert.

N.B.: die Stoff und Lederversion unterscheiden sich durch die je nach Form und Abmessung verschieden positionierten Kissennähte.

Optional: Tablett 50x30 cm und 80x30 cm in Kernleder in den Farben Mokka und Schwarz.

Structure : en métal. Accoudoirs et dossiers en bois.

Préparation de la structure : polyuréthane expansé à hauteurs différenciés et à haute résilience. Première doublure en fibre thermoliée avec une toile en coton blanc.

Sangles : sangles élastiques tressées à haute teneur en caoutchouc.

Coussins : rembourrage des coussins d'assise et dossier en duvet d'oie à secteurs avec élément central en polyuréthane haute résilience.

Base : en métal de section ovale 40x20 mm avec finition Black-Nickel polie et anti-glissement de protection en PVC.

Déhoussage : revêtement en tissu entièrement déhoussable en démontant les bases en métal, mais fixe dans la version en cuir.

N.B. : les coutures des coussins des éléments revêtus en cuir sont positionnées suivant leur formes et leur dimensions d'une façon différente des éléments revêtus en tissu.

Optionnel : plateau 50x30 cm et 80x30 cm en cuir sellier Moka ou Noir.

FINITURA BASE BASE FINISH

METALLO | METAL

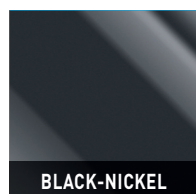

BLACK-NICKEL

Minotti

cod. HI189

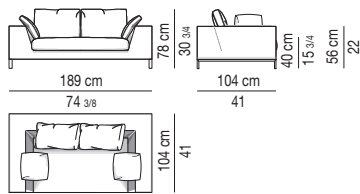

cod. HI218

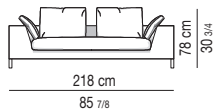

cod. HI230

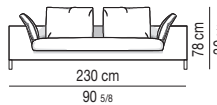

cod. HI125

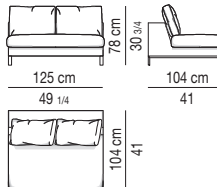

cod. HI157

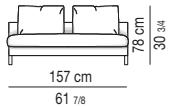

cod. HI157S (SX)
cod. HI157D (DX)

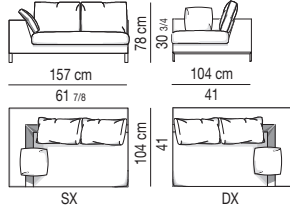

cod. HI186S (SX)
cod. HI186D (DX)

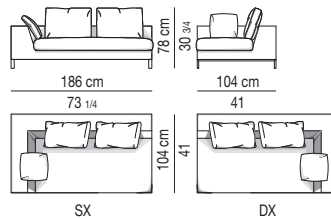

cod. HI208S (SX)
cod. HI208D (DX)

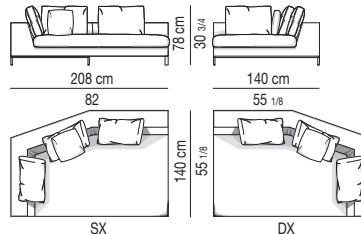

cod. HI140S (SX)
cod. HI140D (DX)

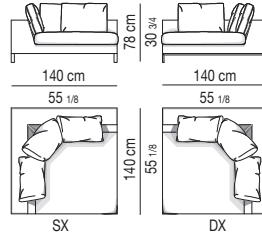

cod. HI157QS (SX)
cod. HI157QD (DX)

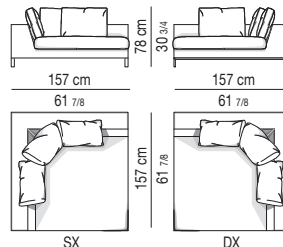

Minotti

cod. HI104S (SX)
cod. HI104D (DX)

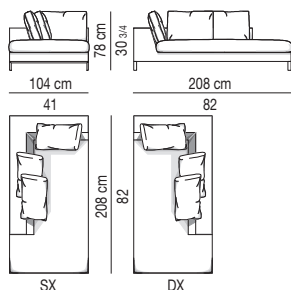

cod. HI157CCBS (SX)
cod. HI157CCBD (DX)

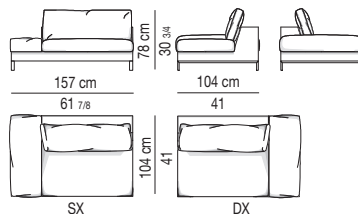

cod. HI140

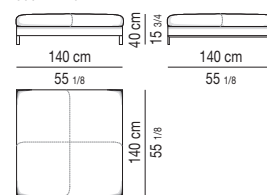

cod. HI194S (SX)
cod. HI194D (DX)

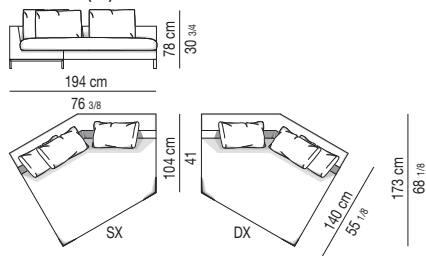

cod. HI237CCBS (SX)
cod. HI237CCBD (DX)

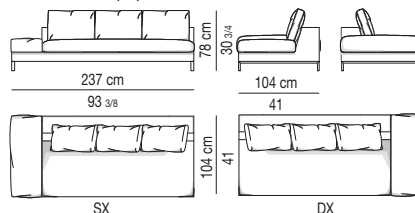

cod. HI140E

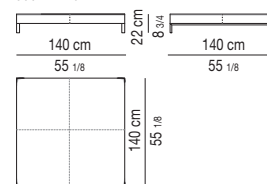

cod. HI194TS (SX)
cod. HI194TD (DX)

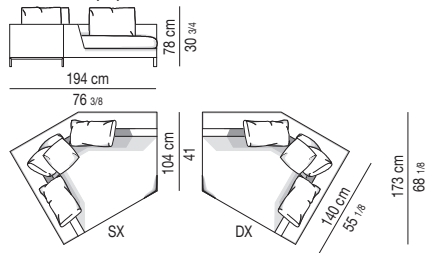

cod. HI237S (SX)
cod. HI237D (DX)

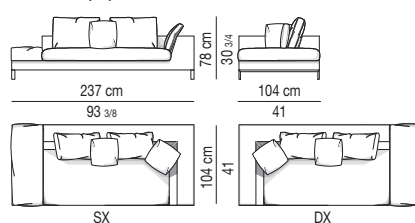

cod. HI104

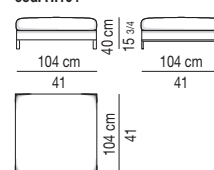

cod. HI245S (SX)
cod. HI245D (DX)

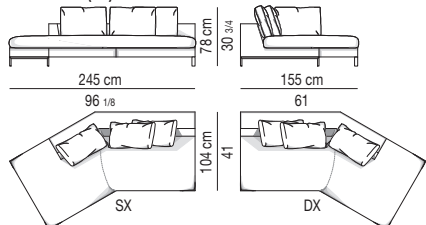

cod. HI157CIS (SX)
cod. HI157CID (DX)

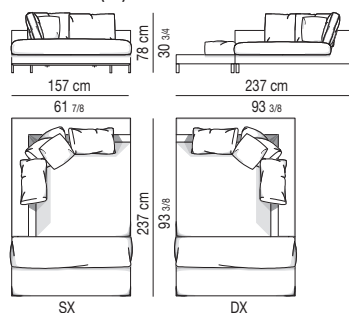

VASSOIO | TRAY

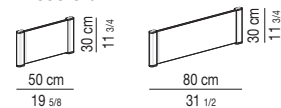

cod. HI157IS (SX)
cod. HI157ID (DX)

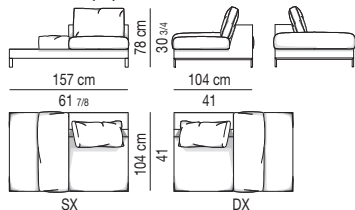

cod. HI237IS (SX)
cod. HI237ID (DX)

