

FLY AIR

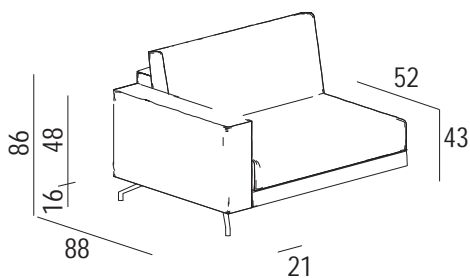



- IT** **STRUTTURA:** costruita in abete massello e multistrato e rivestita in poliuretano espanso. Parti secondarie e non strutturali in pannelli di fibra di legno.
SEDUTE: imbottite in poliuretano espanso ad alta densità e dacron, rivestite da una fodera di piuma d'oca.
SCHIENALI: imbottiti in piuma d'oca.
BASAMENTO: in metallo verniciato colore moka.
SFODERABILITÀ: sfoderabile in tessuto, parzialmente sfoderabile nella versione pelle.

- UK** **STRUCTURE:** made of solid and plywood spruce and covered with expanded polyurethane. Secondary and non-structural parts in fibreboard panels.
SEATS: padded with high density expanded polyurethane foam and synthetic batting, upholstered with a goose feather cover.
BACKS: padded with goose goose feather.
BASEMENT: varnished metal in a moka finish.
REMOVABLE COVERS: removable for fabrics, partially removable for the leather version.

FLY AIR

* tessuto tinta unita h. 1,4 mt

* plain colour fabric h. 1,4 mt

codice

code

vol. m³

peso | weight kg

* ml occorrenti

* lm employed

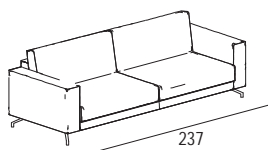

DIVANO 3 POSTI
3-SEATER SOFA

0604303

1,74
83

12

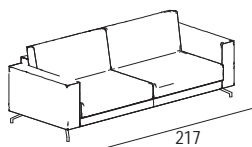

DIVANO 2,5 POSTI
2,5-SEATER SOFA

0604310

1,59
75

11,5

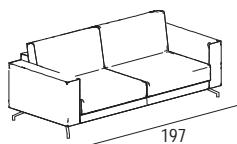

DIVANO 2 POSTI
2-SEATER SOFA

0604302

1,44
68

11

SX
LH

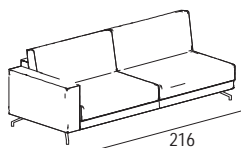

LATERALE 3 POSTI
3-SEATER SIDE ELEMENT

0604304

1,58
75

10,5

SX
LH

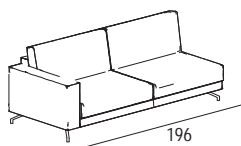

LATERALE 2,5 POSTI
2,5-SEATER SIDE ELEMENT

0604311

1,44
68

10

SX
LH

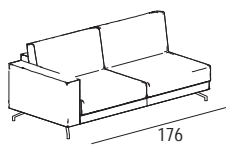

LATERALE 2 POSTI
2-SEATER SIDE ELEMENT

0604305

1,29
61

9,5

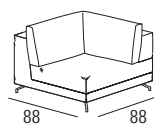

ANGOLO
CORNER

0604312

0,65
60

8

SX
LH

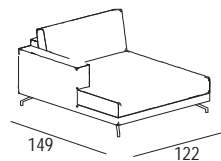

ISOLA
SECTIONAL ELEMENT

0604307

1,51
61

7,5

FLY AIR

* tessuto tinta unita h. 1,4 mt

* plain colour fabric h. 1,4 mt

codice

code

vol. m³

peso | weight kg

* ml occorrenti

* lm employed

DX

RH

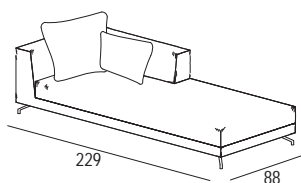

MERIDIANA GRANDE

BIG CHAISE LONGUE

0604315

1,68

57

10

DX

RH

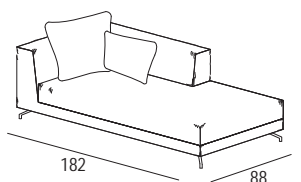

MERIDIANA PICCOLA

SMALL CHAISE LONGUE

0604306

1,33

50

9,5

OPTIONAL

Cuscino | Cushion
65 x 65

06CUSC3

0,004

0,3

0,65

Cuscino | Cushion
45 x 45

06CUSC1

0,003

0,3

0,55



FLY AIR

* tessuto tinta unita h. 1,4 mt

* plain colour fabric h. 1,4 mt

codice

code

vol. m³

peso | weight kg

* ml occorrenti

* lm employed

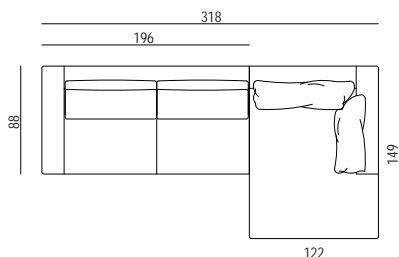

- LATERALE 2,5 POSTI SX
- ISOLA DX

- 2,5-SEATER SIDE ELEMENT - LH
- SECTIONAL ELEMENT - RH

FLY AIR 1

2,95

129

17,5

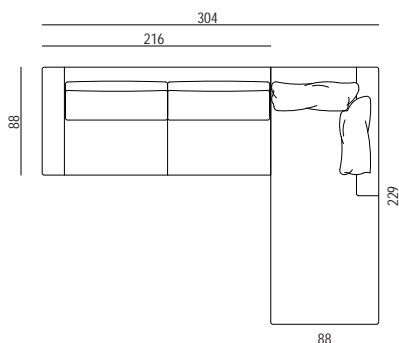

- LATERALE 3 POSTI SX
- MERIDIANA GRANDE DX

- 3-SEATER SIDE ELEMENT - LH
- BIG CHAISE LONGUE - RH

FLY AIR 2

3,26

132

20,5

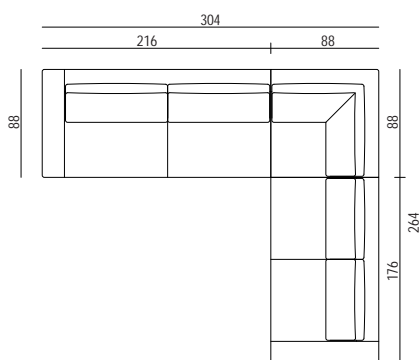

- LATERALE 3 POSTI SX
- ANGOLO
- LATERALE 2 POSTI DX

- 3-SEATER SIDE ELEMENT - LH
- CORNER
- 2-SEATER SIDE ELEMENT - LH

FLY AIR 3

3,52

196

28

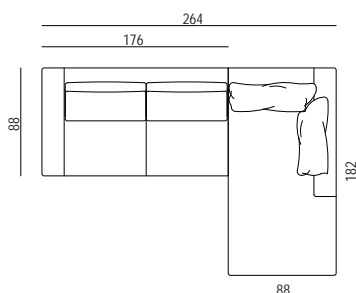

- LATERALE 2 POSTI SX
- MERIDIANA PICCOLA DX

- 2-SEATER SIDE ELEMENT - LH
- SMALL CHAISE LONGUE - RH

FLY AIR 4

2,62

111

19