

PORTLAND

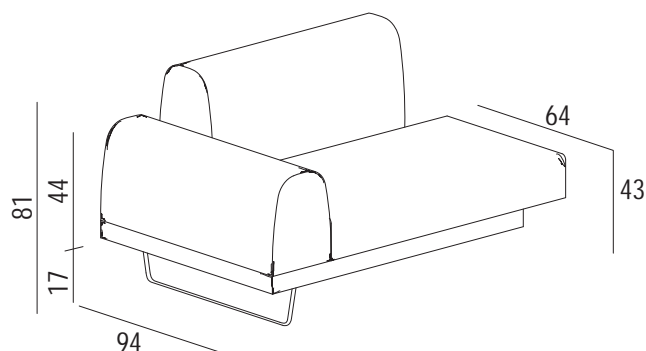



- IT** **STRUTTURA:** costruita in abete massello e multistrato e rivestita in poliuretano espanso. Parti secondarie e non strutturali in pannelli di fibra di legno.
SEDUTE: imbottite in poliuretano espanso sagomato e indeformabile e rivestite con dacron.
SCHIENALI E BRACCIOLI: imbottiti in poliuretano espanso sagomato e indeformabile e rivestite con dacron.
PIEDINI: in ferro verniciato moka.
SFODERABILITÀ: totalmente sfoderabile in tessuto, sfoderabile solo la seduta nella versione pelle.

- UK** **STRUCTURE:** made of solid and plywood spruce and covered with expanded polyurethane. Secondary and non-structural parts in fibreboard panels.
SEATS: padded with expanded polyurethane foam shaped, non deformable and covered with synthetic batting.
BACKS AND ARMRESTS: padded with expanded polyurethane foam shaped, non deformable and covered with synthetic batting.
FEET: varnished metal in a moka finish.
REMOVABLE COVERS: totally removable for fabrics, only seat removable for the leather version.

PORTLAND

* tessuto tinta unita h. 1,4 mt

* plain colour fabric h. 1,4 mt

codice

code

vol. m³

peso | weight kg

* ml occorrenti

* lm employed

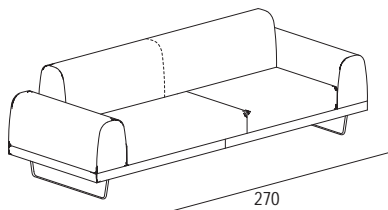

DIVANO 3 POSTI
3-SEATER SOFA

0604403

2,10
95

9,4

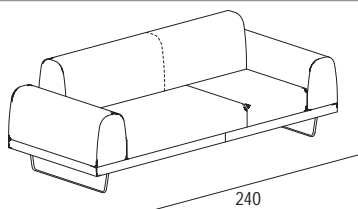

DIVANO 2,5 POSTI
2,5-SEATER SOFA

0604410

1,87
85

9,4

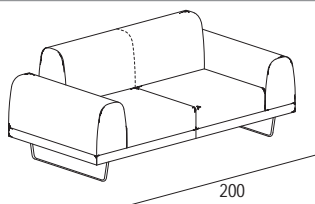

DIVANO 2 POSTI
2-SEATER SOFA

0604402

1,57
75

7,2

SX
LH

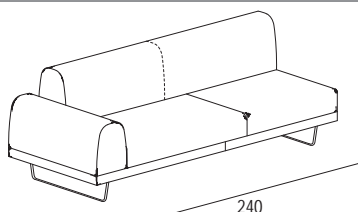

LATERALE 3 POSTI
3-SEATER SIDE ELEMENT

0604404

1,87
85

8,3

SX
LH

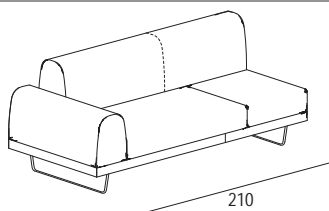

LATERALE 2,5 POSTI
2,5-SEATER SIDE ELEMENT

0604411

1,64
77

8,3

SX
LH

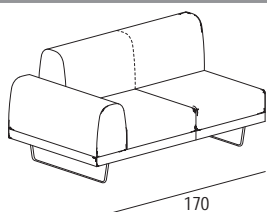

LATERALE 2 POSTI
2-SEATER SIDE ELEMENT

0604405

1,33
70

6

DX
RH

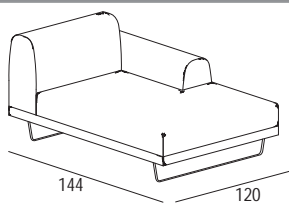

ISOLA
SECTIONAL ELEMENT

0604407

1,44
75

6,6

DX
RH

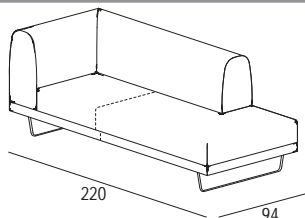

MERIDIANA
CHAISE LONGUE

0604406

1,72
83

9,4

PORTLAND

* tessuto tinta unita h. 1,4 mt

* plain colour fabric h. 1,4 mt

codice

code

vol. m³

peso | weight kg

* ml occorrenti

* lm employed

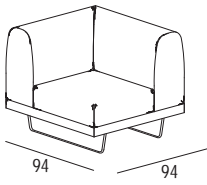

ANGOLO
CORNER

0604412

0,74
43

6

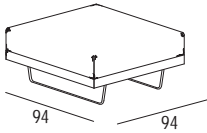

POUF QUADRATO
SQUARE POUF

0604400

0,39
20

3,9

OPTIONAL

Cuscino | Cushion
65 x 65

06CUSC3

0,004
0,3

0,65



Cuscino | Cushion
45 x 45

06CUSC1

0,003
0,3

0,55

PORTLAND

* tessuto tinta unita h. 1,4 mt

* plain colour fabric h. 1,4 mt

codice

code

vol. m³

peso | weight kg

* ml occorrenti

* lm employed

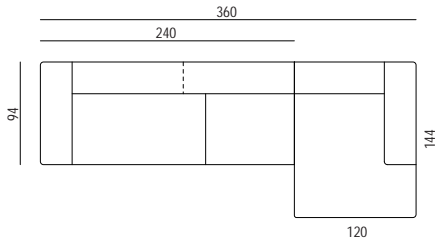

- LATERALE 3 POSTI SX
- ISOLA DX

- 3-SEATER SIDE ELEMENT - LH
- SECTIONAL ELEMENT - RH

PORTLAND 1

3,31

160

14,9

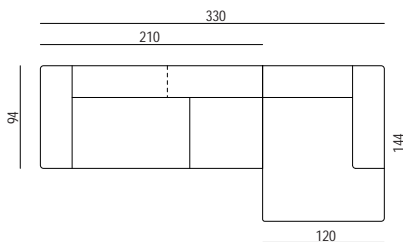

- LATERALE 2,5 POSTI SX
- ISOLA DX

- 2,5-SEATER SIDE ELEMENT - LH
- SECTIONAL ELEMENT - RH

PORTLAND 2

3,08

152

14,9

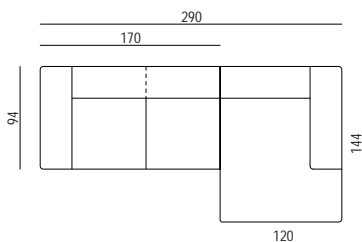

- LATERALE 2 POSTI SX
- ISOLA DX

- 2-SEATER SIDE ELEMENT - LH
- SECTIONAL ELEMENT - RH

PORTLAND 3

2,77

145

12,6

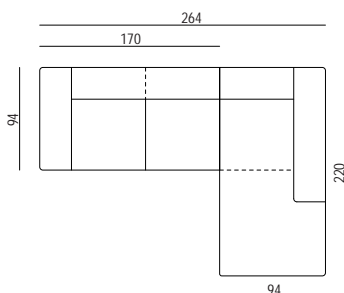

- LATERALE 2 POSTI SX
- MERIDIANA DX

- 2-SEATER SIDE ELEMENT - LH
- CHAISE LONGUE - RH

PORTLAND 4

3,05

153

17,7