

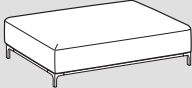









Sanders air outdoor



	 Bases - Bases	 Backrests - Dossiers	 Low-cut - Fantasmio	
Upholstering <i>Revetement</i> (10)	Removable <i>Déhoussable</i>			
	Not removable <i>Non déhoussable</i>	—	—	—
Padding <i>Rembourrages</i> (3-4-5-6-7-8-9)	 +  D.35kg/m³	 +  D.75/25kg/m²+ metal weight		

TECHNICAL INFORMATION

Structure: 1

Load-bearing blocks in okumè wood of various thicknesses. Infill sides in okumè multilayer blockboard wood.

Base in painted metal with outdoor treatment.

Coffee tables with base in painted metal with outdoor treatment and top in iroko wood.

Springing: 2

The seat is supported by propylene and latex elastic belts.

Notes:

Pre-lining in breathable water-repellent material.

Heat-sealed water-repellent cover available upon request (for technical specifications see Materials, Finishes and Warnings page).

Heat-sealed water-repellent cover available upon request (for technical specifications see Finishes page).

INFORMATIONS TECHNIQUES

Structure: 1

Blocs porteurs en bois okumè de différentes épaisseurs. Panneaux de remplissage en bois de lattes multicouches d'okumè.

Base en métal peint avec traitement outdoor.

Tables basses avec base en métal peint avec traitement outdoor et plateau en bois d'iroko.

Suspension: 2

Assise avec sangles élastiques de fibre propylénique et latex.

Note:

Pré-doublure en matière respirante et déperlante.

Disponible sur demande housse hydrofuge thermosoudée (pour les spécifications techniques voir pour les spécifications techniques voir page matériaux, finitions et avertissements).

Disponible sur demande housse hydrofuge thermosoudée (pour les spécifications techniques voir page finitions).

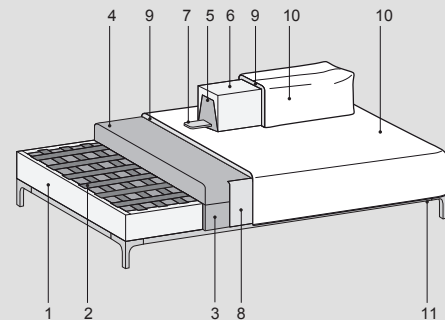
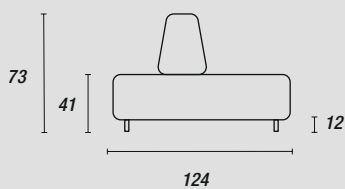

Base - Piètement::

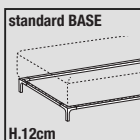

Light brown (ME11)

Accessories - Accessoires:



Iroko (LE20)