

# FLOS

F1595023 Dark Grey/Olive Green

## Chiara Table

LED retrofit - 10W



Table lamp composed of a reflecting body in aluminium in 3 colour variations, finished internally with an opaque white plastic film and folded and closed via hooks riveted to the sheet metal. A coloured seal in moulded tpu runs along the entire profile of the body. The internal base in extruded aluminium is attached to the body for stability and it also supports the bulb socket. The power cable has a dimmer switch to adjust the brightness. Usable cable length: 1.9 m

Are you a professional and your project needs consulting and support?

[BOOK AN APPOINTMENT](#)

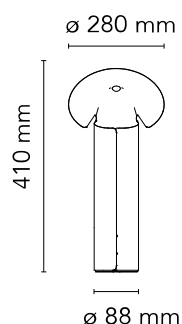

### Main specifications

EAN	8059607032312
Mounting	Table
Environments	Indoor dry location
Light Source Type	Bulb
Lamp category	LED retrofit
Lamp holders	E14
Ilcos	HSGS
Number of heads	1
Power (W)	10

### Physical

Colour	Dark Grey/Olive Green
Cord length (mm)	1900
Net weight (kg)	1.32
Package height (mm)	0
Package width (mm)	0
Package length (mm)	0
Package volume (m3)	0.06
IP internal	20

### Download

[Mounting instructions](#)  PDF

[Spare Parts](#)  PDF

### Photometric Files

[LDT / IES](#)  LDT



# Schematic light drawing

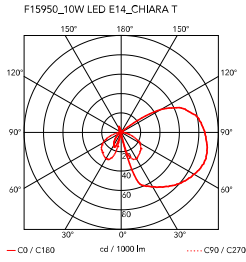

## Photometric

Lighting type	Indirect
Light distribution	Asymmetric

## Electrical

Insulation class	II
Frequency (Hz)	50/60
Main voltage (Vac)	100-240
LED voltage Vf (Vdc)	null
Dimmable	Yes
Dimming interface	Dimmer Integrated
Plug type	Type C
Batteries inside	No

## Bulbs

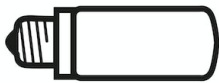

NOT INCLUDED

RF32290

LED Lamp E14 8W 2700K T28

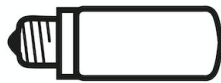

NOT INCLUDED

RF32291

LED Lamp E14 8W 3000K T28



NOT INCLUDED

RF32767

LED Lamp 9W E14 220-240V  
2700K T28

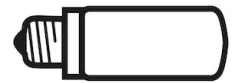

NOT INCLUDED

RF32768

LED Lamp 9W E14 220-240V  
3000K T28

## Spare Parts

01. Dimmer 4-25W 220-240V Black

RF32262

**DOWNLOAD**

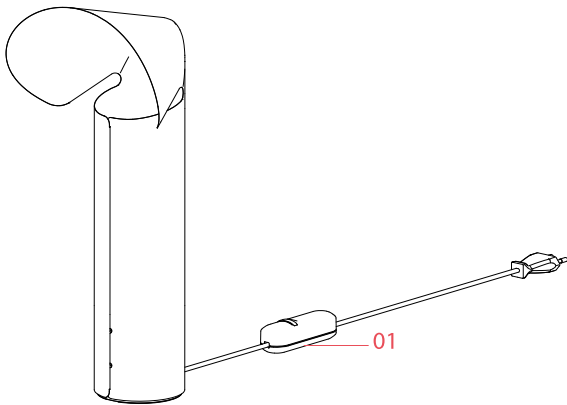

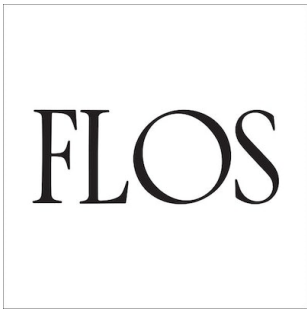

RF32262

Dimmer 4-25W 220-240V Black

# FLOS

F1595034 Pink Gold/Oxide Red

## Chiara Table

LED retrofit - 10W

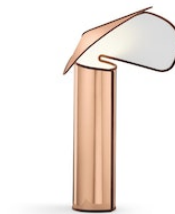
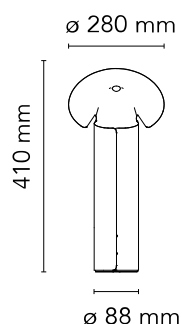

Table lamp composed of a reflecting body in aluminium in 3 colour variations, finished internally with an opaque white plastic film and folded and closed via hooks riveted to the sheet metal. A coloured seal in moulded tpu runs along the entire profile of the body. The internal base in extruded aluminium is attached to the body for stability and it also supports the bulb socket. The power cable has a dimmer switch to adjust the brightness. Usable cable length: 1.9 m

Are you a professional and your project needs consulting and support?

[BOOK AN APPOINTMENT](#)



### Main specifications

EAN	8059607032329
Mounting	Table
Environments	Indoor dry location
Light Source Type	Bulb
Lamp category	LED retrofit
Lamp holders	E14
Ilcos	HSGS
Number of heads	1
Power (W)	10

### Physical

Colour	Pink Gold/Oxide Red
Cord length (mm)	1900
Net weight (kg)	1.32
Package height (mm)	0
Package width (mm)	0
Package length (mm)	0
Package volume (m3)	0.06
IP internal	20

### Download

[Mounting instructions](#)  PDF

[Spare Parts](#)  PDF

### Photometric Files

[LDT / IES](#)  LDT



## Schematic light drawing

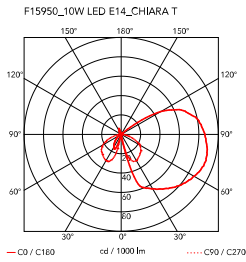

### Photometric

Lighting type	Indirect
Light distribution	Asymmetric

### Electrical

Insulation class	II
Frequency (Hz)	50/60
Main voltage (Vac)	100-240
LED voltage Vf (Vdc)	null
Dimmable	Yes
Dimming interface	Dimmer Integrated
Plug type	Type C
Batteries inside	No

## Bulbs

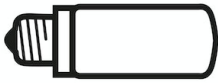

NOT INCLUDED

RF32290

LED Lamp E14 8W 2700K T28

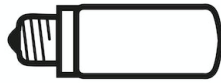

NOT INCLUDED

RF32291

LED Lamp E14 8W 3000K T28

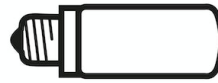

NOT INCLUDED

RF32767

LED Lamp 9W E14 220-240V  
2700K T28

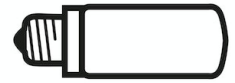

NOT INCLUDED

RF32768

LED Lamp 9W E14 220-240V  
3000K T28



## Spare Parts

01. Dimmer 4-25W 220-240V Black RF32262

**DOWNLOAD**

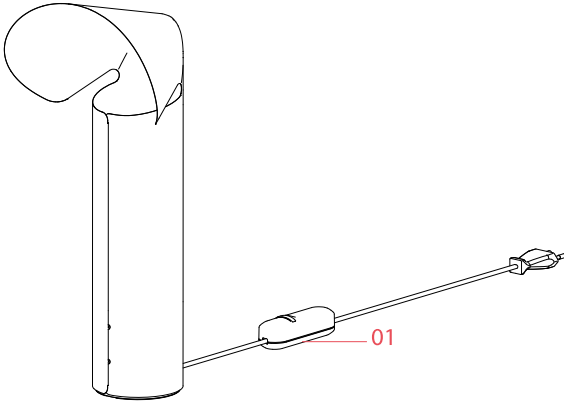

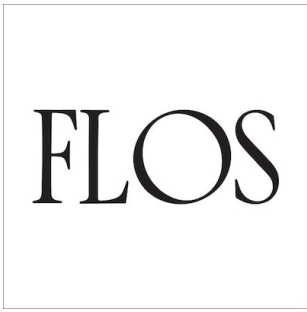

RF32262

Dimmer 4-25W 220-240V Black

# FLOS

F1595004 Aluminium/Anthracite

## Chiara Table

LED retrofit - 10W



Table lamp composed of a reflecting body in aluminium in 3 colour variations, finished internally with an opaque white plastic film and folded and closed via hooks riveted to the sheet metal. A coloured seal in moulded tpu runs along the entire profile of the body. The internal base in extruded aluminium is attached to the body for stability and it also supports the bulb socket. The power cable has a dimmer switch to adjust the brightness. Usable cable length: 1.9 m

Are you a professional and your project needs consulting and support?

[BOOK AN APPOINTMENT](#)

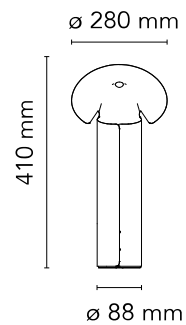

### Main specifications

EAN	8059607032305
Mounting	Table
Environments	Indoor dry location
Light Source Type	Bulb
Lamp category	LED retrofit
Lamp holders	E14
Ilcos	HSGS
Number of heads	1
Power (W)	10

### Physical

Colour	Aluminium/Anthracite
Cord length (mm)	1900
Net weight (kg)	1.32
Package height (mm)	0
Package width (mm)	0
Package length (mm)	0
Package volume (m3)	0.06
IP internal	20

### Download

[Mounting instructions](#)  PDF

[Spare Parts](#)  PDF

### Photometric Files

[LDT / IES](#)  LDT



## Schematic light drawing

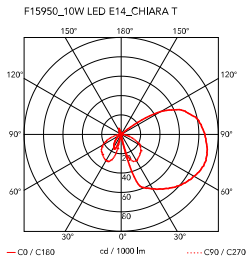

### Photometric

Lighting type	Indirect
Light distribution	Asymmetric

### Electrical

Insulation class	II
Frequency (Hz)	50/60
Main voltage (Vac)	100-240
LED voltage Vf (Vdc)	null
Dimmable	Yes
Dimming interface	Dimmer Integrated
Plug type	Type C
Batteries inside	No

## Bulbs

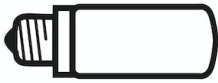

NOT INCLUDED

RF32290

LED Lamp E14 8W 2700K T28

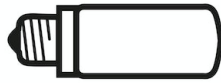

NOT INCLUDED

RF32291

LED Lamp E14 8W 3000K T28

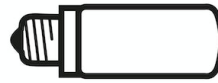

NOT INCLUDED

RF32767

LED Lamp 9W E14 220-240V  
2700K T28



NOT INCLUDED

RF32768

LED Lamp 9W E14 220-240V  
3000K T28

## Spare Parts

01. Dimmer 4-25W 220-240V Black RF32262

**DOWNLOAD**

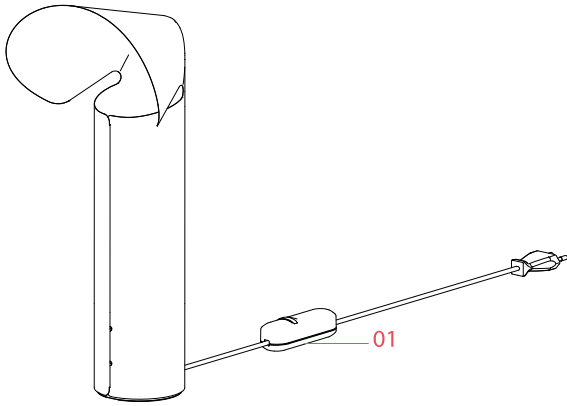

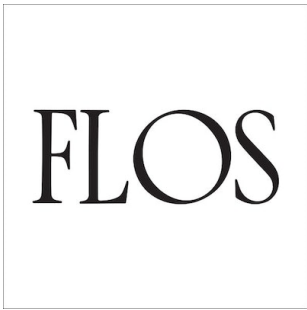

RF32262

Dimmer 4-25W 220-240V Black