

BONALDO

Alley

Designer: **Giuseppe Viganò**



A succession of rigid lines and soft shapes that culminates in a harmonious union between minimalism and creative flair. Designed by Giuseppe Viganò, the Alley chair stands out on account of its bold metallic frame and understated but distinctive presence. The alternation of full and empty spaces

gives dynamism and continuity to the seat, while the slender legs create a sense of seriousness and lightness. The low backrest completes the clean and light design and balances the frame, emphasizing its contemporary style.



Технические данные

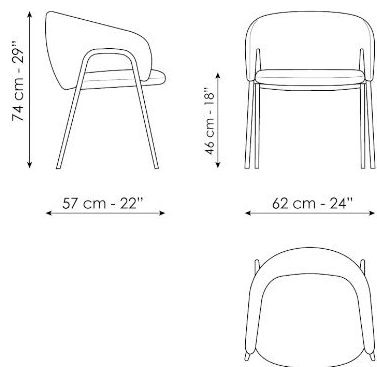

Alley

Ширина: 57cm

Глубина: 62cm

Высота: 74cm

Finishes

ОБИВКА

Ткань - 900

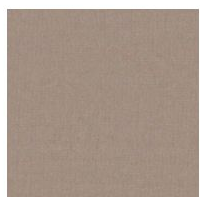

Ткань - Azimut
9B02



Ткань - Azimut
9B08

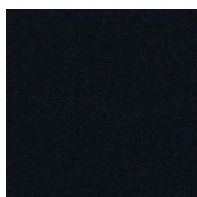

Ткань - Azimut
9B17



Ткань - Azimut
9B22



Ткань - Azimut
9B26



Ткань - Azimut
9B36



Ткань - Azimut
9B39



Ткань - Azimut
9B42



Ткань - Azimut
9B44

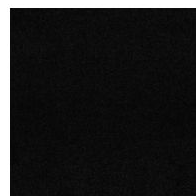

Ткань - Azimut
9B48



Fabric - Newco
9B65

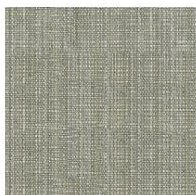

Fabric - Newco
9B66



Fabric - Newco
9B67



Fabric - Newco
9B68



Fabric - Newco
9B69



Fabric - Newco
9B70



Fabric - Newco
9B71



Fabric - Newco
9B72

Ткань - Must



Ткань - Boemian
MC40

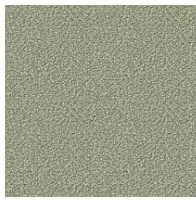

Ткань - Boemian
MC43

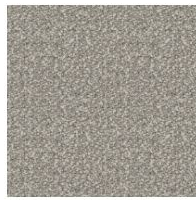

Ткань - Boemian
MC46



Ткань - Boemian
MC47



Ткань - Boemian
MC49

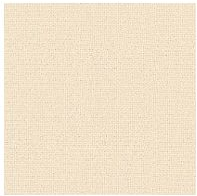

Ткань - Rico
MA02

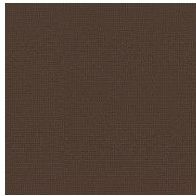

Ткань - Rico
MA04

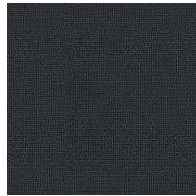

Ткань - Rico
MA07



Ткань - Rico
MA09



Ткань - Rico
MA11



Ткань - Rico
MA20

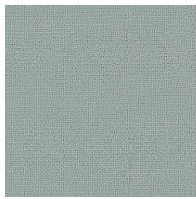

Ткань - Rico
MA22

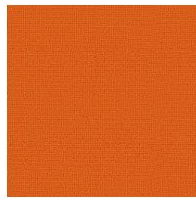

Ткань - Rico
MA39



Ткань - St. Moritz
MC60



Ткань - St. Moritz
MC61



Ткань - St. Moritz
MC62



Ткань - St. Moritz
MC67



Ткань - St. Moritz
MC69

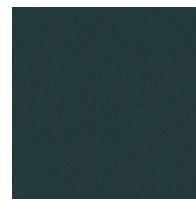

Ткань - St. Moritz
MC76



Ткань - St. Moritz
MC81

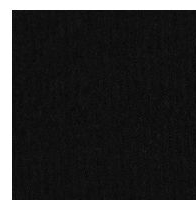
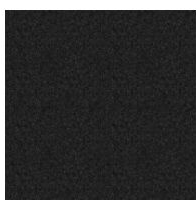

Ткань - St. Moritz
MC83

Ткань - St. Moritz
MC85



Ткань - Flora
MD30



Ткань - Flora
MD31



Ткань - Flora
MD32



Ткань - Flora
MD34



Ткань - Flora
MD35



Ткань - Flora
MD37



Ткань - Flora
MD39



Fabric - Lucky
MD58



Fabric - Lucky
MD59



Fabric - Lucky
MD60

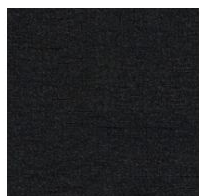

Fabric - Lucky
MD61

Ткань - Special



Ткань - Ваia
SP45



Ткань - Ваia
SP48



Ткань - Ваia
SP50

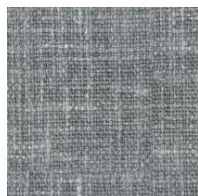

Ткань - Ваia
SP51



Ткань - Ваia
SP52



Fabric - Jurga
SP53



Fabric - Jurga
SP54



Fabric - Jurga
SP55



Fabric - Jurga
SP56



Fabric - Jurga
SP57

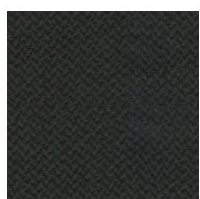

Fabric - Jurga
SP58

Ткань - 800



Ткань - Pastello
8D69



Fabric - Pastello
8D68



Fabric - Pastello
8D67



Fabric - Pastello
8D66



Fabric - Pastello
8D65



Fabric - Pastello
8D64



Fabric - Pastello
8D63



Fabric - Pastello
8D62



Fabric - Pastello
8D61



Fabric - Pastello
8D60



Fabric - Pastello
8D59



Fabric - Pastello
8D58



Fabric - Pastello
8D57



Fabric - Pastello
8D56



Fabric - Pastello
8D55



Fabric - Pastello
8D54

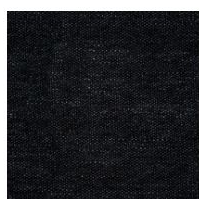

Fabric - Pastello
8D53



Fabric - Pastello
8D52

Ткань - Class



Fabric - Hyle
EB55



Fabric - Hyle
EB56



Fabric - Hyle
EB57



Fabric - Hyle
EB58



Fabric - Hyle
EB59



Fabric - Hyle
EB60



Fabric - Hyle
EB61



Fabric - Hyle
EB62

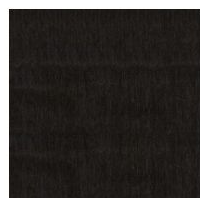

Fabric - Hyle
EB63



Fabric - Hyle
EB64

НОЖКИ

Металл категория Plus

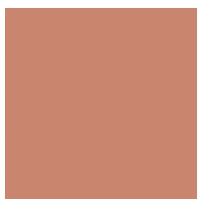

Крашенный металл
Матовая медь



Крашенный металл
Матовая латунь

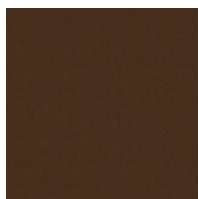

Крашенный металл
Матовый
бронзовый

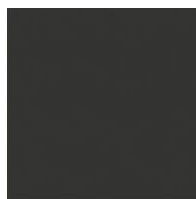

Крашенный металл
Матовый свинец



Металл крашенный
Матовое
перламутровое
золото

металл

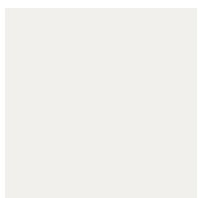

Крашенный металл
Матовый белый



Крашенный металл
Матовый
коричневый

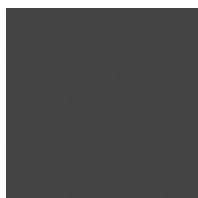

Крашенный металл
Supreme anthracite

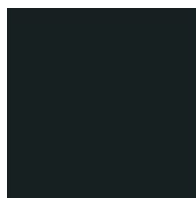

Крашенный металл
Матовый черный



Крашенный металл
Матовый светло-
коричневый с
серым оттенком

Металл категория Special



Металлическая
отделка
Clouded chrome

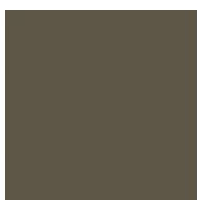

Металлическая
отделка
Brown nickel

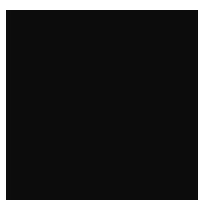

Металлическая
отделка
Dark nickel

Materials, fabrics, leathers, colors and finishes are approximate and may slightly differ from actual ones. You can find the complete collection of Bonaldo fabrics and leathers on the website

