



Yura

W 546 Giuseppe Iasparra

Struttura in legno di faggio, con cinghie elastiche ricoperta in poliuretano espanso ad alta densità. Cuscini di seduta e schienale in piuma d'oca sterilizzata, con inserto in poliuretano espanso a quote differenziate. Base di legno nello stesso rivestimento del divano. I braccioli sono completamente rivestiti oppure possono avere un piano di servizio in metallo coordinato con l'anello collocato alla base della struttura nelle finiture: oro chiaro lucido, oro Champagne opaco, cromato lucido, cromo nero lucido, bronzo satinato opaco. Il rivestimento in tessuto (togliendo l'anello di metallo) è completamente sfoderabile.

DISEGNI TECNICI

scala 1:50

Divani / Sofas / Диваны

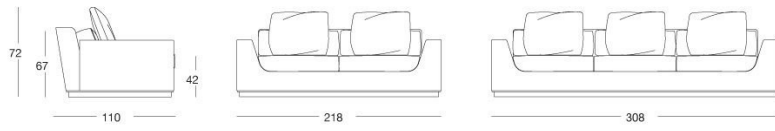

Terminali Sx / End unit L.H. / Боковые секции Л

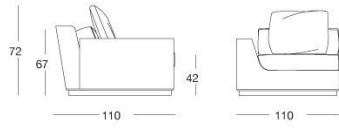

Terminali Dx / End unit R.H. / Боковые секции П

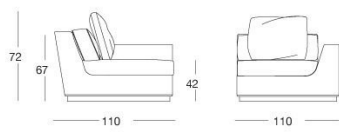

Angolo / Corner / Угловой элемент

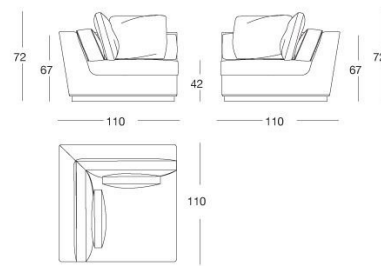

Poltrona / Armchair / Кресло

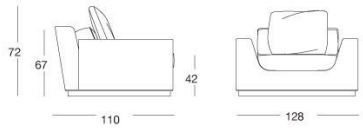

Centrali / Central / Центральные секции

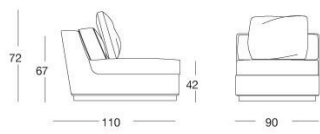

Dormeuse / Dorteuse / Дормез

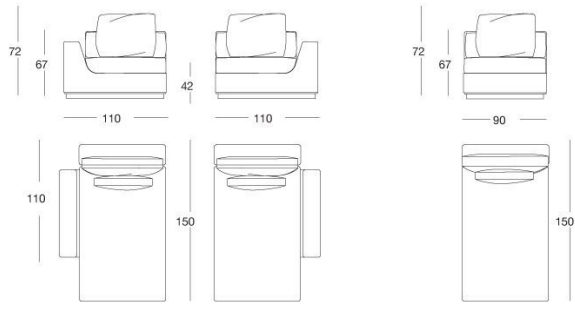

Pouf / Ottoman / Пуф

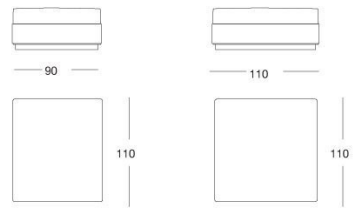

Composizione speciale / Special composition / Особая композиция

